

nomon
JEWELRY FOR HOME

CLOCKS COLLECTION

WE CREATE JEWELRY FOR YOUR HOME

Creamos joyas
para tu hogar



UNIÓN EUROPEA

FONDO EUROPEO DE
DESARROLLO REGIONA

UNA MANERA DE HACER EUROPA

Nomon Culture
P.6-P.13

Designers
P.14-P.15

Premium Collection
P.16-P.45

Soft collection
P.46-P.59

Rings Collection
P.60-P.119

Pendulum Collection
P.120-P.141

Time Signals Collection
P.142-P.165

Table / Floor Collections
P.166-P.179

Átomo Collection
P.180-P.193

Marble Collection
P.194-P.201

OJ Clock
P.202-P.209

Pun Collection
P.210-P.225

Custom Made
P.226-P.233

WORLD OF NOMON

Nomon is the leader company in indoor clocks, with a presence in over 90 countries. We produce visually stunning pieces, where the clock ceases to be a mere accessory and becomes the protagonist, decorating the walls of homes, offices, receptions, and all types of facilities.

Creativity, design, and technology are the three main principles that mark Nomon products. The result is original clocks of avant-garde design and high quality, produced following artisanship methods combined with innovative techniques.

Nomon es la empresa líder en relojes de interior, con presencia en más de 90 países. Producimos piezas de gran impacto visual, en las que el reloj deja de ser un complemento y se convierte en protagonista, vistiendo las paredes de hogares, oficinas, recepciones y todo tipo de instalaciones.

Creatividad, diseño y tecnología; son los tres principios esenciales que marcan nuestros productos. El resultado son relojes originales, de diseño vanguardista y gran calidad, producidos de forma artesanal aplicando técnicas innovadoras.





NOMON HISTORY

Historia de Nomon

The history of Nomon began more than 20 years ago, as the result of the union between the furniture designer José María Reina and the jewelry designer Àngels Arrufat. The fusion of their know how gave rise to a new concept of jewelry clock, unique so far. Together they dared to break barriers and surpass old pre-established canons, where the clock simply marked the hours, and the jewelry the status.

They believed in an innovative idea that, beyond the functional and decorative aspects, elevated the wall clock to a much more premium category. And they created it following three main pillars: absolute respect for tradition, high quality materials and a completely novel design, common to the best contemporary furniture brands.

A concept that rapidly paved its way across renowned architects and interior designers.

La historia de Nomon inició hace más de 20 años, fruto de la unión entre el diseñador de mobiliario José María Reina y la diseñadora de joyas Àngels Arrufat. La fusión de su know how dio pie a un nuevo concepto de reloj joya, único hasta el momento.

Juntos se atrevieron a romper barreras y sobrepasar antiguos cánones preestablecidos, donde el reloj simplemente marcaba las horas, y las joyas el estatus.

Creieron en una idea innovadora que, más allá de los aspectos funcionales y decorativos, alzaba el reloj de pared a una categoría mucho más premium. Y lo hicieron con tres pilares muy claros: absoluto respeto por la tradición, materiales de alta calidad y un diseño totalmente novedoso, afín a las mejores marcas de mobiliario contemporáneo. Un concepto que caló rápidamente entre arquitectos e interioristas de renombre.

HANDMADE CLOCKS

Hecho a mano

Our clocks are unique handmade pieces, slight variations might be possible since the clocks are produced with natural materials and artisan finishes. The brand nomon has an exclusive character due to the delicate processes used, as well as to its exquisite presentation and the attention paid to every detail. All our products are fully manufactured in Spain and include a German-origin quartz.

Nuestros relojes son piezas únicas fabricadas a mano, las variaciones que pueden presentar son debidas a que se producen con materiales naturales y acabados artesanales. Los delicados procesos utilizados, la cuidada presentación y la atención por los detalles aportan a la firma nomon su carácter exclusivo. Todos nuestros productos están íntegramente fabricados en España con mecanismo alemán.



DESIGN & ENVIRONMENT

Diseño & medioambiente

At Nomon, sustainability is based on designing timeless quality objects that will last as much as possible.

Producing with common sense and avoiding the consumption of unnecessary resources, putting quality before quantity.

Working with local artisans and suppliers is the essential foundation in our commitment to sustainability, as it reduces our products carbon footprint and promotes the circular economy.

La sostenibilidad para Nomon se basa en diseñar objetos atemporales de calidad que perduraran el mayor tiempo posible.

Producir con sentido común y no consumir más de lo necesario, anteponiendo la calidad a la cantidad.

Otro pilar esencial en nuestro compromiso sostenible es trabajar con artesanos locales y proveedores de nuestro entorno, lo que reduce la huella de carbono y promueve la economía circular.





Designer JOSÉ MARÍA REINA

JOSÉ MARÍA REINA José María Reina (Utrera, Sevilla 1951 - Barcelona 2016) founder of Nomon, versatile and self-taught designer. Multifaceted and self-taught designer of the generation that promoted Barcelona as a capital city in industrial design. His multidisciplinary work in the furniture and jewelry design areas, led him to fusing both projects together, creating a new clock concept. His clocks have a renewed aesthetics reflected both in shapes and materials. Thanks to his designs, the wall clock has regained its prominence, becoming once again a piece of prestige and distinction in our homes, offices, and facilities.

JOSÉ MARÍA REINA Diseñador polifacético y autodidacta de la generación que impulsó a Barcelona como capital referente del diseño industrial. Su trabajo multidisciplinar en sectores como el mueble y la relojería le llevó a fusionar ambos proyectos creando un nuevo concepto de reloj, con una estética renovada tanto en las formas como en los materiales. Gracias a sus diseños, el reloj de pared ha recuperado su protagonismo, volviendo a ser una pieza de prestigio y distinción en nuestros hogares, oficinas e instalaciones.



Designer ANDRÉS MARTÍNEZ

ANDRÉS MARTÍNEZ Born in Córdoba in a family with jewelry tradition, his designs are recognized by the fidelity to noble materials and craftsmanship, and the search for authentic luxury: serene, restrained, and timeless.

ANDRÉS MARTÍNEZ Nacido en Córdoba en el seno de una familia de tradición joyera, sus creaciones se reconocen por la fidelidad a los materiales nobles y la artesanía en la búsqueda del auténtico lujo sereno, contenido y atemporal.

PREMIUM COLLECTION

NOMON PRESENTS THE NEW PREMIUM GOLD COLLECTION, REVISITING THE MOST ICONIC MODELS AND RAISING THEM TO A SOPHISTICATED LEVEL.

Nomon presenta la nueva colección Premium en la que renueva algunos de los modelos más icónicos de la marca, elevándolos a un nivel más premium y sofisticado.



Barcelona Premium
P.6-7



Mini Barcelona Premium
P.10-13



Bilbao Premium
P.14-15



Mini Bilbao Premium
P.17



Delmori Premium
P.18-21



Dos Puntos Premium Gold
P.22-23



Doble O Premium Gold
P.24-25



Péndulo Premium
P.26-27



Punto y Coma Premium
P.30-31



BARCELONA PREMIUM ø90cm

Renovation of one of the most representative models of nomon, the iconic Barcelona clock. Incorporating a more glamorous style in the design. It stands out for the brass finish in its fiberglass double ring.

Renovación de uno de los modelos más representativos de Nomon, el icónico reloj Barcelona. Incorporando un punto más glamouroso en su diseño, destaca por el acabado de latón de su doble aro de fibra de vidrio.

WE WANT TO REMOVE THE OBVIOUS AND HIGHLIGHT THE IMPORTANT.

Queremos eliminar lo obvio
y destacar lo importante.





MINI BARCELONA PREMIUM ø66cm

Premium version of the Mini Barcelona model, where design, aesthetics and quality continue to prevail above all else.

Versión premium del modelo Mini Barcelona, donde el diseño, la estética y la calidad siguen primando por encima de todo.







BILBAO PREMIUM ø106cm

A bestseller model, perfect for any space. Its large walnut hands elegantly follow the sphere's contour.

Un bestseller perfecto para cualquier estancia. Sus grandes agujas de nogal recorren el contorno de la esfera con elegancia.



THE QUALITY OF THE MATERIALS CONNECTS US WITH TRADITION, TRUTH AND HONESTY

La calidad de los materiales nos relaciona con
la tradición, la verdad y la honestidad



MINI BILBAO PREMIUM ø78cm

A new and more sophisticated version of the Mini Bilbao model.
The combination of walnut and golden details enhances its presence.

Nueva versión más sofisticada del modelo Mini Bilbao. La combinación entre
el nogal y los detalles dorados potencian y realzan su presencia.



DELMORI PREMIUM ø130cm

We present the brand's most spectacular clock in its premium version.
A unique piece due to its large dimensions and delicate details.

Presentamos al reloj más espectacular de la marca en su versión premium.
Una pieza única por su grandes dimensiones y delicados detalles.



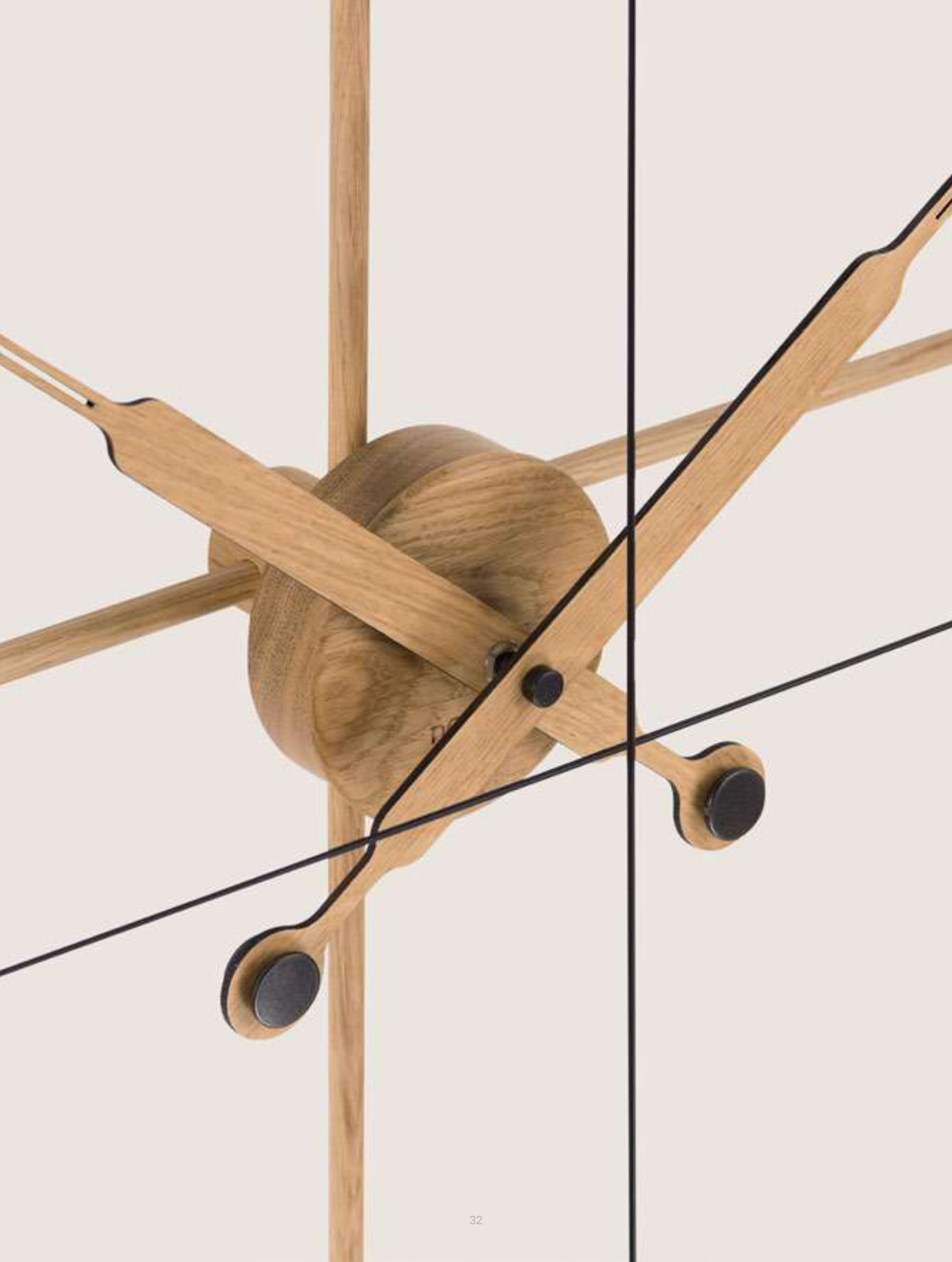



DOS PUNTOS PREMIUM GOLD ø43cm

Clock that exudes elegance and sophistication, with rings made of polished brass, combined with hands in natural walnut wood.

Reloj con aros de latón pulido que, combinado con agujas en madera de nogal natural, destila elegancia y sofisticación.

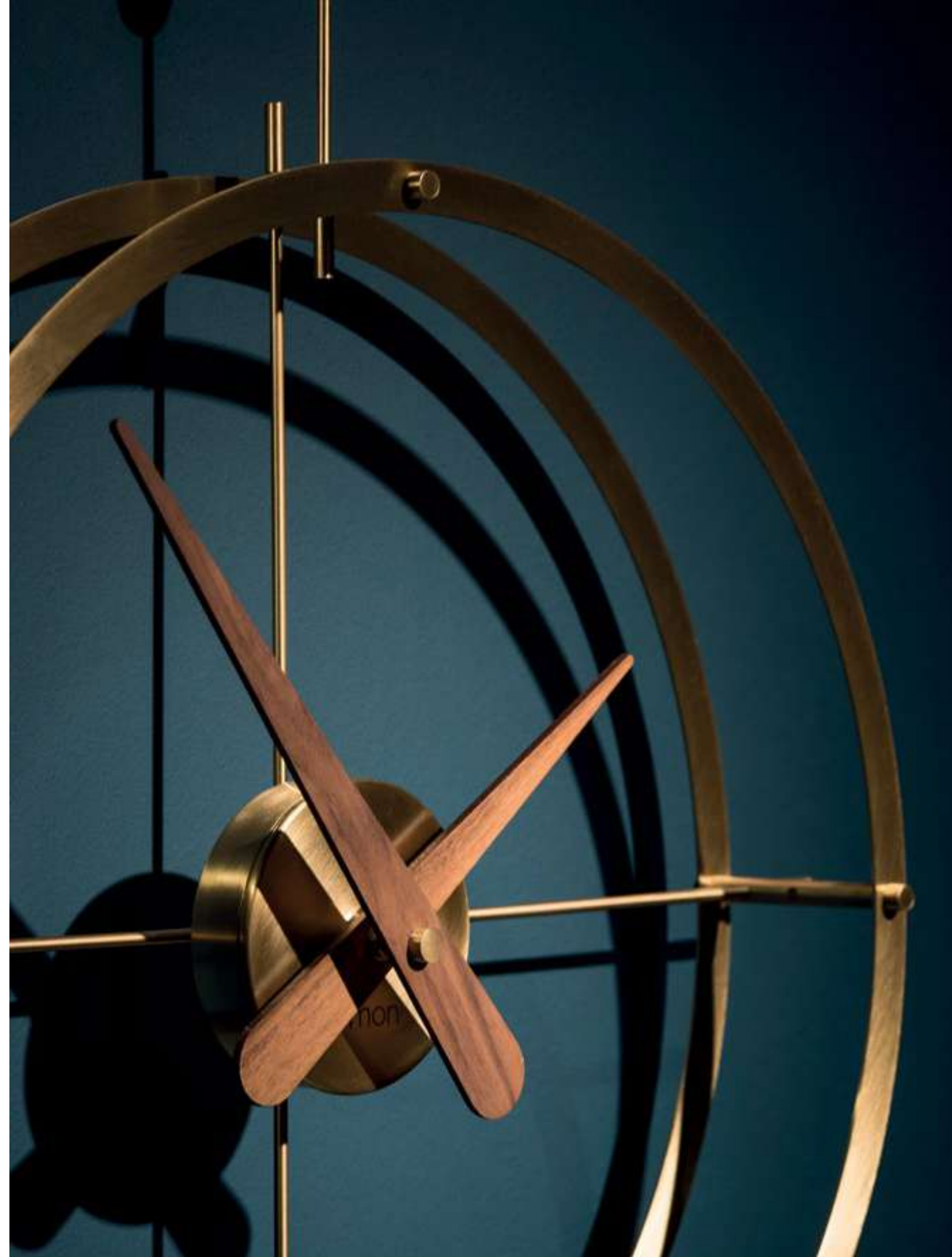



DOBLE O PREMIUM GOLD ø70cm

Laborious and acknowledged model, composed of a double polished brass ring and walnut hands.

Modelo muy laborioso y exitoso, compuesto por un doble aro de latón y agujas de nogal.



PÉNDULO PREMIUM ø66cm / L max. 4m

A tribute that aims to recover the prestige of grandfather pendulum clocks by renewing their aesthetics. It can be installed on the wall or to the ceiling.

Un homenaje que pretende recuperar el prestigio de los relojes de péndulo renovando su estética. Puede instalarse a pared o techo.



WE LOVE CRAFTSMANSHIP AND NOBLE MATERIALS.

*Amamos la artesanía
y los materiales nobles*





PUNTO Y COMA PREMIUM ø46cm · L112cm

Walnut and brass details elevate the presence of the Punto y Coma model.
An essential piece for those who want to add personality to a sober environment.

La madera de nogal y los detalles de latón elevan la presencia del modelo
Punto y Coma. Una pieza imprescindible para aquellos que quieran aportar
personalidad en un entorno sobrio.



Premium TECHNICAL INFORMATION

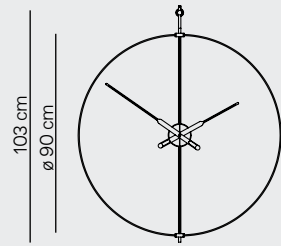

BARCELONA PREMIUM WALNUT
 Box in walnut wood / Caja en madera de nogal
 Hands in walnut wood / Agujas en madera de nogal
 Rings in gold or black fiberglass/ Aros en fibra de vidrio dorada o negra.

BARCELONA PREMIUM OAK
 Box in oak wood / Caja en madera de roble
 Hands in oak wood / Agujas en madera de roble
 Rings in black fiberglass/ Aros en fibra de vidrio negra.

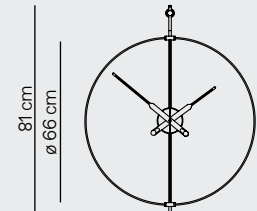

MINI BARCELONA PREMIUM WALNUT
 Box in walnut wood / Caja en madera de nogal
 Hands in walnut wood / Agujas en madera de nogal
 Rings in gold or black fiberglass/ Aros en fibra de vidrio dorada o negra.

BARCELONA PREMIUM OAK
 Box in oak wood / Caja en madera de roble
 Hands in oak wood / Agujas en madera de roble
 Rings in black fiberglass/ Aros en fibra de vidrio negra.

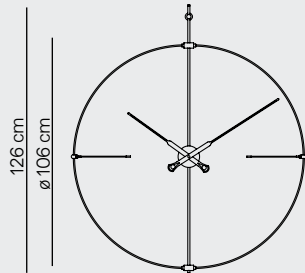

BILBAO PREMIUM WALNUT
 Box in walnut wood / Caja en madera de nogal
 Hands in walnut wood / Agujas en madera de nogal
 Ring in gold or black fiberglass/ Aro en fibra de vidrio dorada o negra.

BILBAO PREMIUM OAK
 Box in oak wood / Caja en madera de roble
 Hands in oak wood / Agujas en madera de roble
 Ring in black fiberglass/ Aro en fibra de vidrio negra.

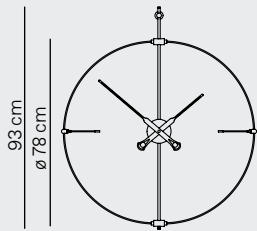

MINI BILBAO PREMIUM WALNUT
 Box in walnut wood / Caja en madera de nogal
 Hands in walnut wood / Agujas en madera de nogal
 Ring in gold or black fiberglass/ Aro en fibra de vidrio dorada o negra.

MINI BILBAO PREMIUM OAK
 Box in oak wood / Caja en madera de roble
 Hands in oak wood / Agujas en madera de roble
 Ring in black fiberglass/ Aro en fibra de vidrio negra.

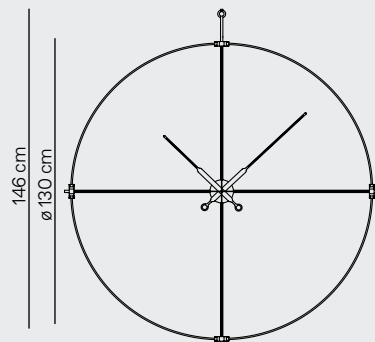

DELMORI PREMIUM WALNUT
 Box in walnut wood / Caja en madera de nogal
 Hands in walnut wood / Agujas en madera de nogal
 Rings in gold or black fiberglass/ Aros en fibra de vidrio dorada o negra.

DELMORI PREMIUM OAK
 Box in oak wood / Caja en madera de roble
 Hands in oak wood / Agujas en madera de roble
 Rings in black fiberglass/ Aros en fibra de vidrio negra.

Premium TECHNICAL INFORMATION

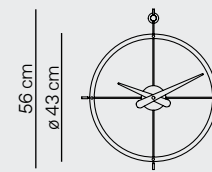

2 PUNTOS PREMIUM GOLD
 Box in polished brass / Caja en latón pulido
 Hands in walnut wood / Agujas en madera de nogal
 Ring in polished brass / Aro en latón pulido

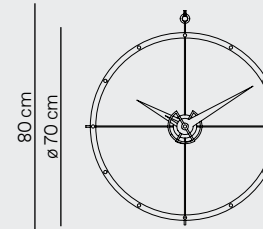

DOBLE O PREMIUM GOLD
 Box in polished brass / Caja en latón pulido
 Hands in walnut wood and polished brass / Agujas en madera de nogal y latón pulido
 Ring in polished brass / Aro en latón pulido

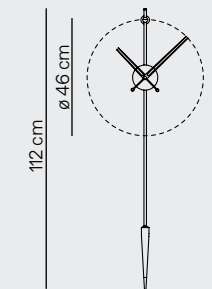

PUNTO Y COMA PREMIUM WALNUT
 Box in walnut wood / Caja en madera de nogal
 Hands in walnut wood / Agujas en madera de nogal
 Pendulum in walnut wood and polished brass / Péndulo en madera de nogal y latón pulido

PUNTO Y COMA PREMIUM OAK
 Box in oak wood / Caja en madera de roble
 Hands in oak wood / Agujas en madera de roble
 Pendulum in oak wood and graphite finished metal / Péndulo en madera de roble y grafito

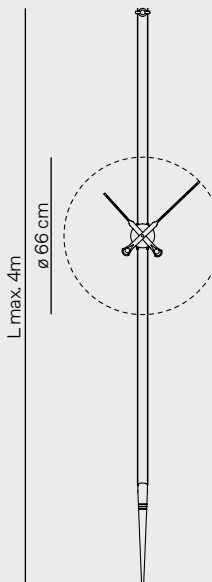

PÉNDULO PREMIUM WALNUT
 Box in walnut wood / Caja en madera de nogal
 Hands in walnut wood / Agujas en madera de nogal
 Pendulum in walnut wood and polished brass / Péndulo en madera de nogal y latón pulido

PÉNDULO G PREMIUM OAK
 Box in oak wood / Caja en madera de roble
 Hands in oak wood / Agujas en madera de roble
 Pendulum in oak wood and graphite finished metal / Péndulo en madera de roble y grafito

SOFT COLLECTION

FOR THE FIRST TIME, NOMON WORKS WITH SUBTLY FOLDED WOODEN STRIPS. THE SILHOUETTE CONNECTS US WITH NATURE, EMULATING AN OPEN FLOWER IN ALL ITS SPLENDOR.

Por primera vez, Nomon trabaja con hojas de madera natural plegadas sutilmente. La silueta nos conecta con la naturaleza, emulando una flor abierta en todo su esplendor.



Ciclo
P.36-39



Brisa
P.40-43



Brisa XL
P.44-45



CICLO ø55cm

Clock made with natural walnut or oak sheets.
The subtle folds of curved wood create three-dimensional shades evoking nature. Hands in walnut, oak finished ash or polished brass.

Reloj compuesto de hojas de nogal o roble natural.
Los sutiles pliegues de madera curvada crean formas tridimensionales que evocan a la naturaleza. Agujas en nogal, fresno acabado roble o latón pulido.





CICLO WALNUT

Clock in natural walnut.
Reloj en nogal natural.



BRISA ø52cm

Model composed of curved natural walnut or oak shades, that emulate a blooming flower.
Hands in walnut, oak stained ash, or polished brass.

Modelo compuesto por hojas de nogal o roble natural curvadas que emulan una flor abierta en todo su esplendor.
Agujas en nogal, fresno acabado roble o latón pulido.





BRISA MIXTO

Versatile model combining
walnut and oak wood shades.

Combina hojas de madera de nogal
y roble aportando versatilidad.



BRISA OAK

Clock in natural oak wood.
Reloj en madera de roble.



BRISA XL ø75cm

Clock made with natural walnut or oak shades and hands in walnut, oak, or polished brass. Astonishing dimensions providing a great visual presence.

Reloj compuesto por hojas de nogal o roble natural y agujas en nogal, fresno acabado roble o latón pulido. Sus espectaculares dimensiones le dan una gran presencia visual.



Soft **TECHNICAL INFORMATION**

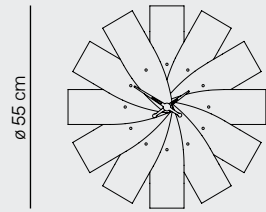

- CICLO WALNUT**
- CINN **Body in walnut wood, walnut hands /**
Cuerpo nogal, agujas de nogal
- CING **Body in walnut wood, hands in polished brass /**
Cuerpo nogal, agujas de latón pulido.
- CINI **Body in walnut wood, hands and time signals in polished brass /**
Cuerpo de nogal, agujas y señales horarias en latón pulido

- CICLO OAK**
- CIRR **Body in oak wood, hands in oak finish /**
Cuerpo roble, agujas acabado roble.
- CIRG **Body in oak wood, hands in polished brass /**
Cuerpo roble, agujas de latón pulido.
- CIRI **Body in oak wood, hands and time signals in polished brass /**
Cuerpo de roble, agujas y señales horarias en latón pulido.

- CICLO MIXTO**
- CIMN **Body in walnut and oak wood, walnut hands /**
Cuerpo nogal y roble, agujas de nogal.
- CIMG **Body in walnut and oak wood, hands in polished brass /**
Cuerpo nogal y roble, agujas de latón pulido.
- CIMI **Body in walnut and oak wood, hands and time signals in polished brass /**
Cuerpo de nogal y roble, agujas y señales horarias en latón pulido

- BRISA WALNUT**
- BRINN **Body in walnut wood, walnut hands /**
Cuerpo nogal, agujas de nogal
- BRING **Body in walnut wood, hands in polished brass /**
Cuerpo nogal, agujas de latón pulido
- BRINI **Body in walnut wood, hands and time signals in polished brass /**
Cuerpo de nogal, agujas y señales horarias en latón

- BRISA OAK**
- BRIRR **Body in oak wood, hands in oak finish /**
Cuerpo roble, agujas acabado roble
- BRIRG **Body in oak wood, hands in polished brass /**
Cuerpo roble, agujas de latón pulido
- BRIRI **Body in oak wood, hands in polished brass /**
Cuerpo de roble, agujas y señales horarias en latón pulido

- BRISA MIXTO**
- BRIMN **Body in walnut and oak wood, walnut hands /**
Cuerpo nogal y roble, agujas de nogal
- BRIMG **Body in walnut and oak wood, hands in polished brass /**
Cuerpo nogal y roble, agujas de latón pulido
- BRIMI **Body in walnut and oak wood, hands and time signals in polished brass /**
Cuerpo de nogal y roble, agujas y señales horarias en latón pulido

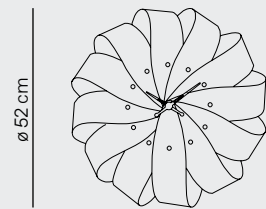

Soft **TECHNICAL INFORMATION**

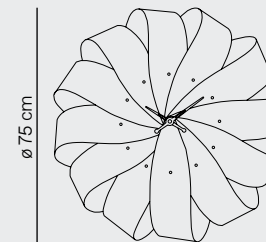

- BRISA XL WALNUT**
- BRIXLNN **Body in walnut wood, walnut hands**
Cuerpo nogal, agujas de nogal
- BRIXLNG **Body in walnut wood, hands in polished brass**
Cuerpo nogal, agujas de latón pulido
- BRIXLNI **Body in walnut wood, hands and time signals in polished brass**
Cuerpo de nogal, agujas y señales horarias en latón

- BRISA XL OAK**
- BRIXLRR **Body in oak wood, hands in oak finish**
Cuerpo roble, agujas acabado roble
- BRIXLRG **Body in oak wood, hands in polished brass**
Cuerpo roble, agujas de latón pulido
- BRIXLRI **Body in oak wood, hands in polished brass**
Cuerpo de roble, agujas y señales horarias en latón pulido

- BRISA XL MIXTO**
- BRIXLMN **Body in walnut and oak wood, walnut hands**
Cuerpo nogal y roble, agujas de nogal
- BRIXLMG **Body in walnut and oak wood, hands in polished brass**
Cuerpo nogal y roble, agujas de latón pulido
- BRIXLMI **Body in walnut and oak wood, hands and time signals in polished brass**
Cuerpo de nogal y roble, agujas y señales horarias en latón pulido

RINGS COLLECTION

THE RINGS COLLECTION INCLUDES NOMON'S MOST ICONIC PIECES, SUCH AS BARCELONA AND BILBAO WALL-CLOCKS. MINIMALIST DESIGN CLOCKS THAT PROVIDE TO YOUR SPACE DISTINGUISHED CHARACTER.

La colección Aros alberga las piezas más icónicas de Nomon, como son los relojes Barcelona y Bilbao.

Relojes de diseño minimalista que aportan un carácter distinguido a la estancia.



Barcelona Series
P.50-59



Bilbao Series
P.60-67



Look Series
P.68-71



Delmori
P.72-77



New Anda Series
P.78-83



Daro Series
P.84-91



Dos Puntos
P. 92-95



Doble O
P.96-99



Cris
P.100-103



BARCELONA ø90cm

Nomon's bestseller par excellence. Its double black fiberglass ring combines pieces of walnut with different metal details and perfectly symbolizes the essence of the brand.
A design icon which became a timeless classic.

El bestseller de Nomon por excelencia. Su doble aro de fibra de vidrio negra, combina piezas de nogal con diferentes acabados metálicos que simbolizan a la perfección la esencia de la marca.
Un icono del diseño, convertido en un clásico atemporal.



BARCELONA

Walnut wood central box, black lacquered walnut hands.
Caja central en madera de nogal, agujas de nogal lacadas negro.



Schöner Wohnen-Kollektion Magazine · Janne Peters
Schöner Wohnen-Farbe Magazine

**WE PRODUCE
VISUALLY
STUNNING PIECES
WITH A GREAT
PERSONALITY AND
IDENTITY.**

Producimos piezas de gran impacto visual,
personalidad e identidad.

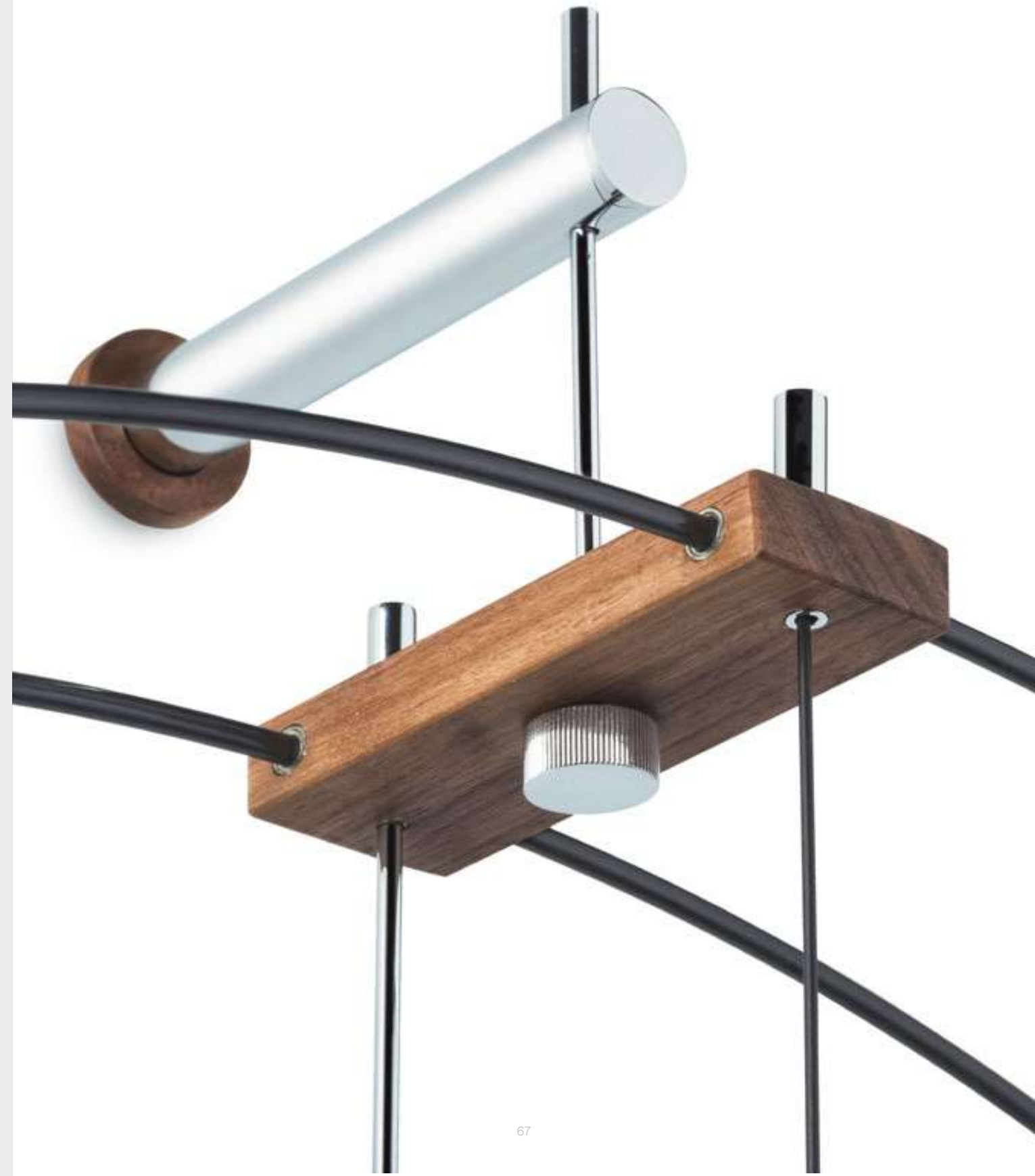



MINI BARCELONA ø66cm

Small version of the iconic Barcelona clock.
Model composed of a black fiberglass double
ring which combines walnut and metallic details.

Versión reducida del exitoso modelo Barcelona.
Reloj compuesto por un doble aro de fibra de vidrio negra,
que combina piezas en nogal con detalles metálicos.





MICRO BARCELONA ø42cm

A charming clock formed by a double ring of black fiberglass, that combines pieces in walnut with metallic details.

Coqueto reloj formado por un doble aro de fibra de vidrio negra, que combina piezas en nogal con detalles metálicos.



MICRO BARCELONA G

Solid walnut and polished brass, fiberglass double ring.
Nogal natural y latón pulido, doble aro de fibra de vidrio.

BILBAO ø105cm

Simplicity and minimalism in its purest form. Clock composed of a black or white fiberglass ring and natural or lacquered walnut hands.

Simplicidad y minimalismo en estado puro. Reloj compuesto por un aro de fibra de vidrio negra o blanca y agujas de nogal natural o lacadas.





BILBAO N

Clock with natural walnut hands and black fiberglass installed in a kitchen.
Instalación de reloj con agujas de nogal natural y fibra de vidrio negra en una cocina.



MINI BILBAO ø77cm

Its slender circumference and the artisan turning of the natural walnut time signals, add a subtle contemporary touch

Su fina circunferencia y el torneado artesanal de las señales horarias de nogal, aportan un toque contemporáneo muy sutil.





MINI BILBAO G

Clock with black fiberglass ring and natural walnut hands.
Central box and details in polished brass.
Reloj con aro de fibra de vidrio negra y agujas de nogal natural.
Caja central y detalles en latón pulido.



LOOK L104 · H48cm

The eye that witnesses the passage of time. Far from the usual circular silhouette, it innovates with its special black fiberglass shape, combining chrome details with natural walnut centre and hands.

El ojo testigo del paso del tiempo. Lejos de la habitual silueta circular, innova por su forma especial de fibra de vidrio negra, combinando detalles cromados con caja y agujas de nogal natural.

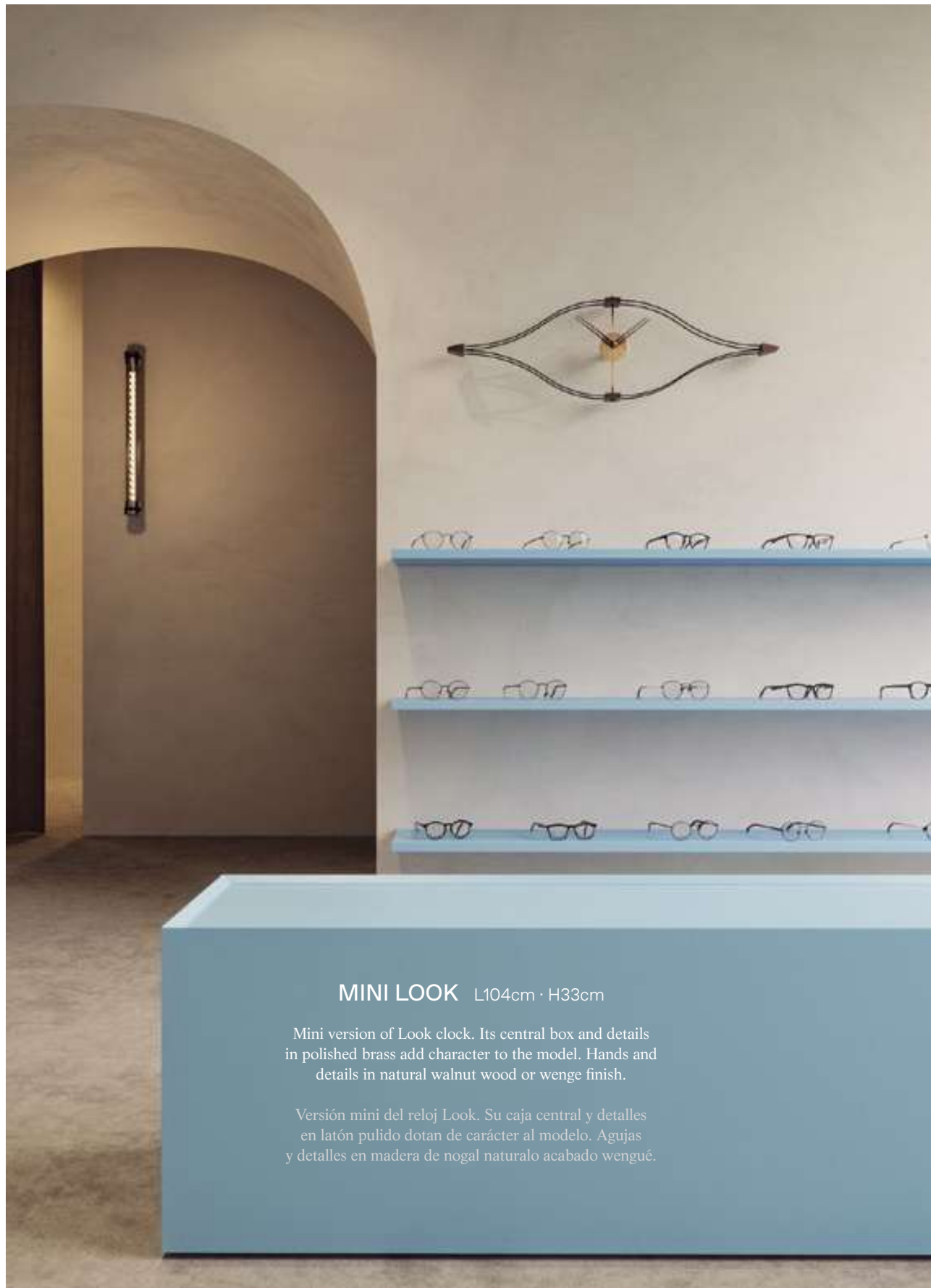

MINI LOOK L104cm · H33cm

Mini version of Look clock. Its central box and details in polished brass add character to the model. Hands and details in natural walnut wood or wengué.

Versión mini del reloj Look. Su caja central y detalles en latón pulido dotan de carácter al modelo. Agujas y detalles en madera de nogal naturalo acabado wengué.

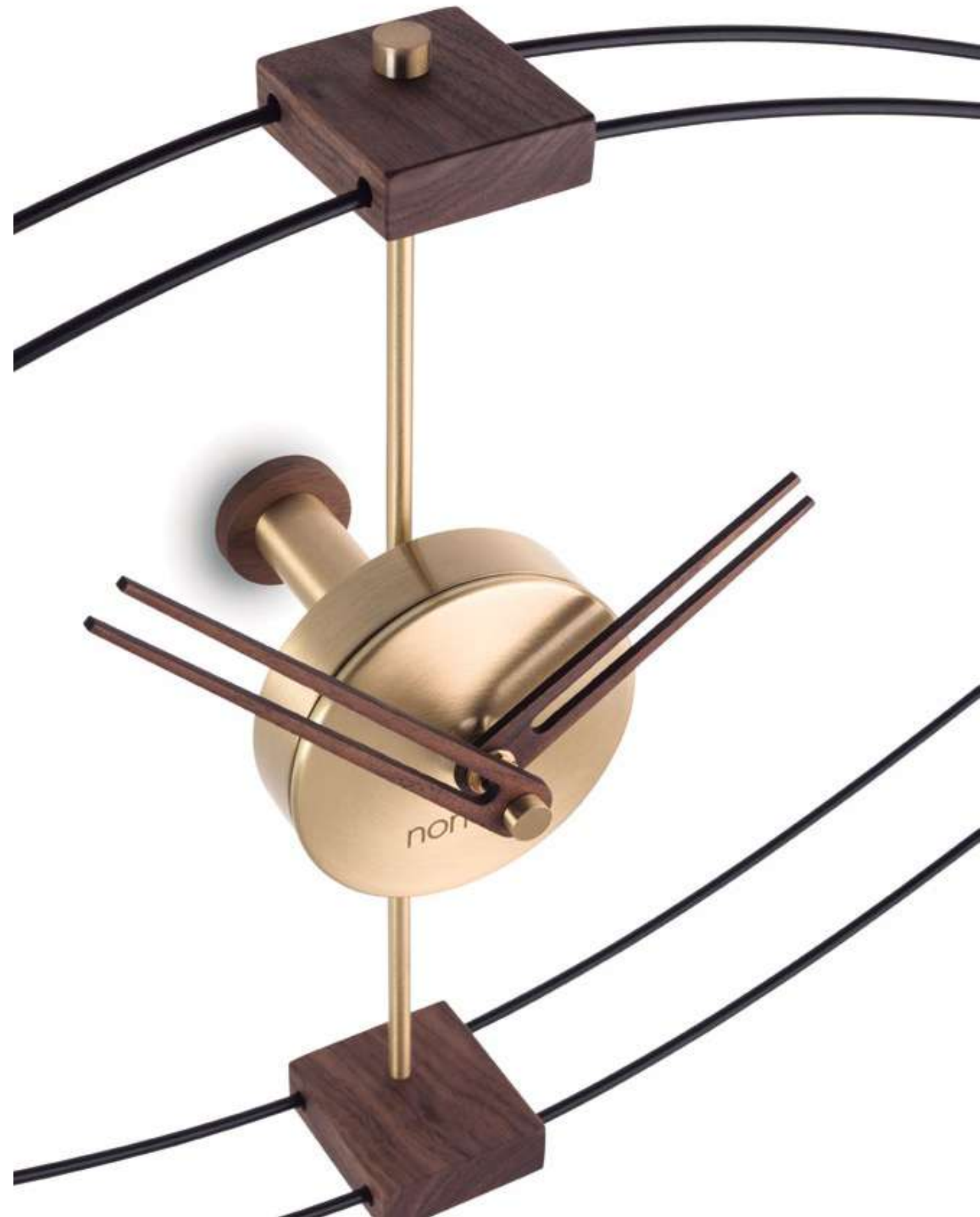

THIS TOUCH OF
LUXURY CAN ONLY
BE OBTAINED
WHEN A HAND
CARESS IS
INVOLVED IN THE
PRODUCTION.

Solo cuando en la fabricación interviene la caricia de una mano, obtenemos ese toque de lujo.

DELMORI ø130cm

Clock with the largest diameter of the collection. It combines a double fiberglass ring with metallic details and natural walnut hands. Due to its lightness, installation is possible hanging from the ceiling or wall.

Reloj con el diámetro más grande de la colección, con doble aro de fibra de vidrio. Combina detalles metálicos con agujas de nogal natural. Posibilidad de instalarlo a pared o a techo gracias a su ligereza.



DELMORI

Clock with natural walnut hands,
black fibreglass ring and chromed details..
Reloj con agujas de nogal natural, fibra de
vidrio negra y detalles metálicos cromados.

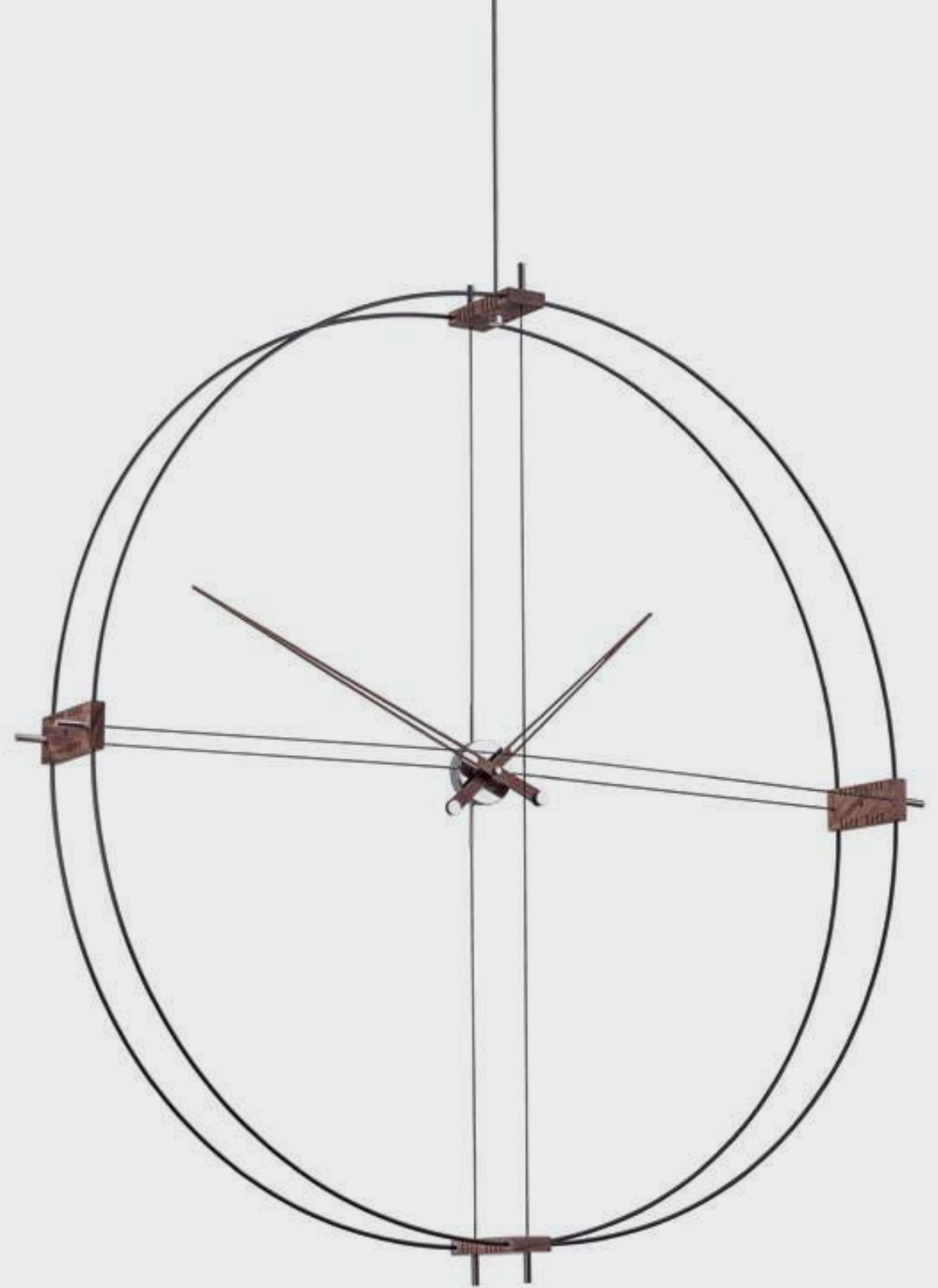

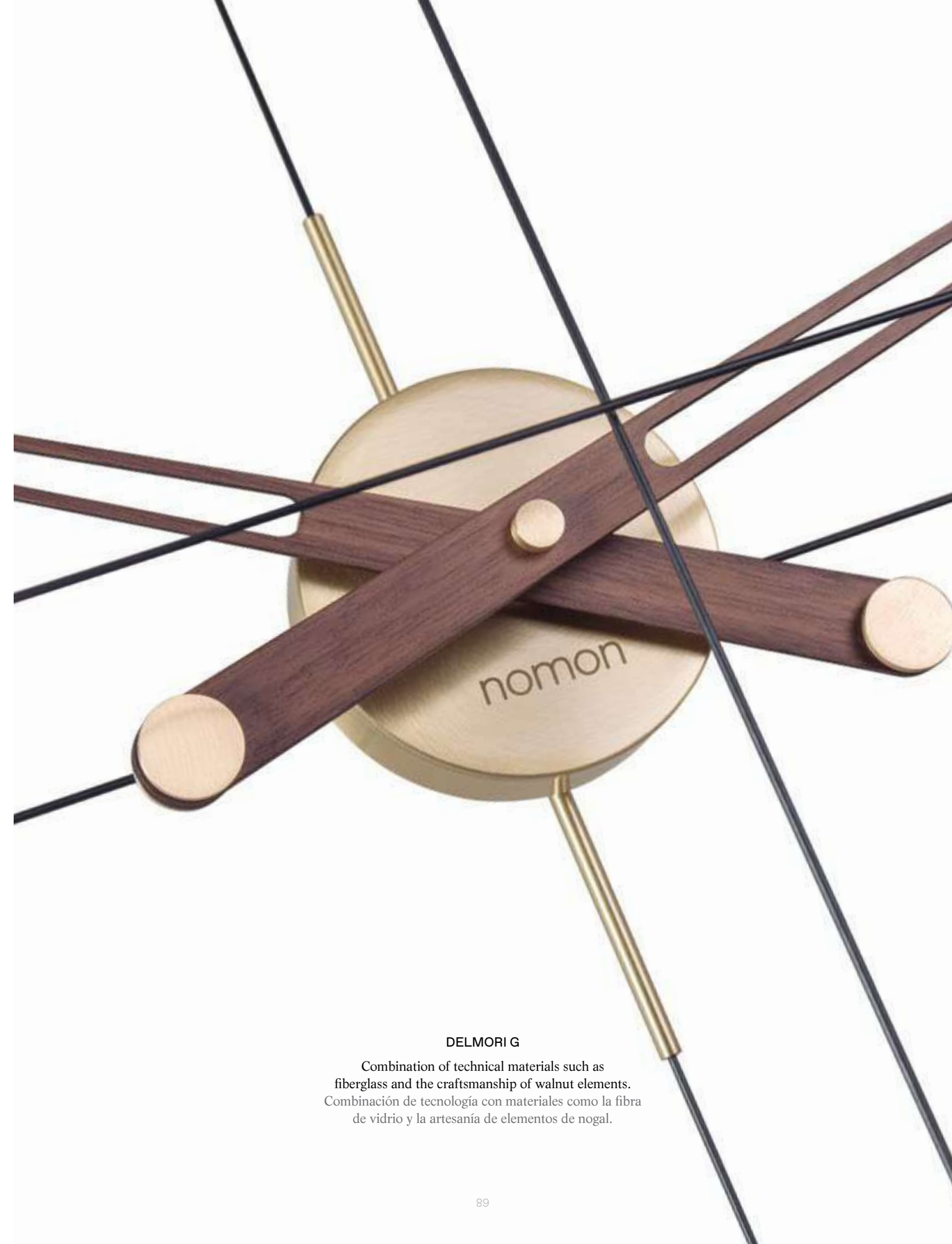

DELMORI G

Combination of technical materials such as fiberglass and the craftsmanship of walnut elements.
Combinación de tecnología con materiales como la fibra de vidrio y la artesanía de elementos de nogal.



NEW ANDA G

Polished brass ring and natural walnut hands.
Aro de latón pulido y agujas de nogal natural.



NEW ANDA ø70cm

A simple suspended metal ring creates a refined object through the simplicity of its forms.
Natural or lacquered walnut hands.

Un simple aro de metal suspendido crea un objeto refinado por la sencillez de sus formas.
Agujas de nogal natural o lacado.

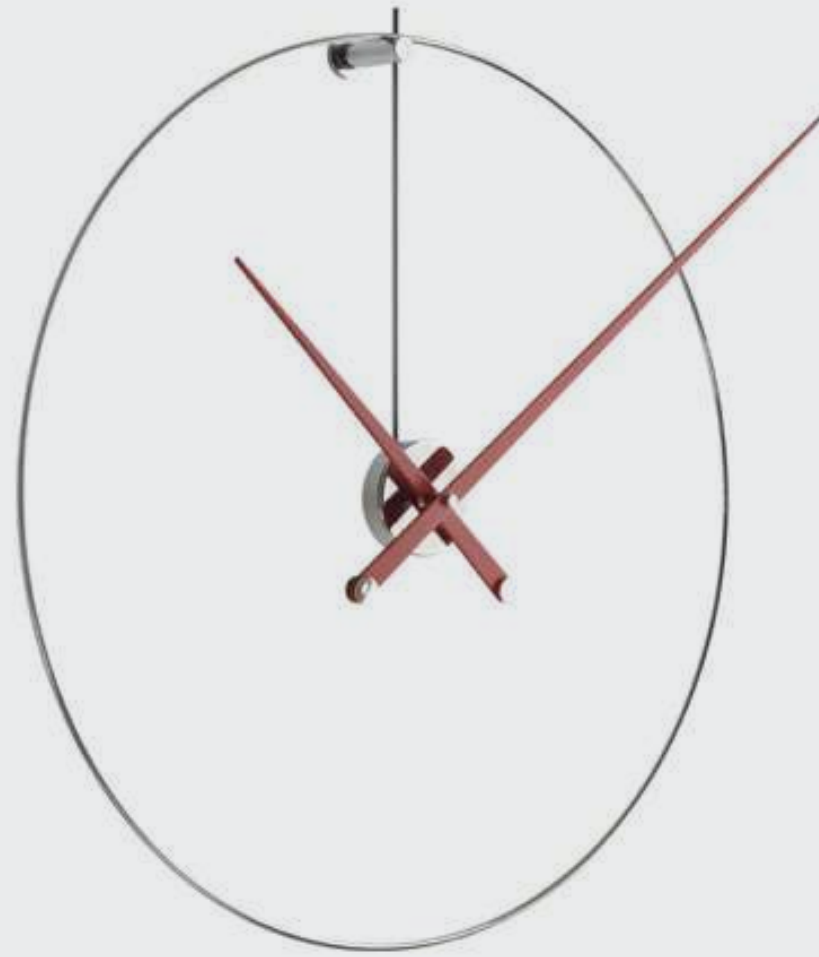

NEW ANDA RED

Clock with a polished steel ring, the hands with a red touch bring strength and personality.
Reloj en acero pulido y agujas con un toque de color rojo que aporta fuerza y personalidad.



NEW ANDA

Clock with polished steel ring and black lacquered walnut hands, office installation.
Reloj en acero pulido y agujas nogal lacado negro instalado en despacho de gerencia.



MICRO ANDA ø40cm

Minimalist design in reduced dimensions which combines a metal ring with natural walnut hands.

Diseño minimalista de reducidas dimensiones que combina un aro metálico con agujas y anclaje en madera de nogal.



MICRO ANDA G

American walnut and polished brass.
Nogal americano y latón pulido.

DARO ø70cm · H108cm

Inspired by jewelry and characterized by its curved, polished brass elements, its design represents a suspended hoop earring. A product that has become a timeless classic.

Inspirado en la joyería y caracterizado por el curvado de sus elementos, su diseño representa un pendiente de aro suspendido. Un producto que se ha convertido en un clásico atemporal.





DARO

Stylized polished brass rod that houses the central box and the suspended ring.

Set in a piece of walnut worked with precision and subtlety.

Estilizada varilla de latón pulido que aloja la caja central y el aro suspendido.

Fijado en una pieza de nogal trabajada con precisión y sutileza.



DARO T

Natural walnut wood hands; graphite finish central box and rings.
Agujas en madera de nogal natural, caja central y aros acabado grafito.





MICRO DARO G

Polished brass ring and natural walnut hands.
Aro de latón pulido y agujas de nogal natural.



MICRO DARO ø40cm · H62,5cm

Elegant and refined reinterpretation of the Daro clock, with walnut hands and a ring in polished or graphite finished brass.

Elegante y refinada reinterpretación del reloj Daro, con agujas en madera de nogal y aro en latón pulido o acabado grafito.



DOS PUNTOS ø43cm

The design of its double ring made of polished steel or wood, combined with its hands, creates a light and ethereal body.

El diseño de su doble aro de acero pulido o madera combinado con sus agujas, crea un cuerpo ligero y etéreo.





DOS PUNTOS i

Polished stainless steel rings and hands, chromed central box.
Aros y agujas en acero inoxidable pulido, caja central cromada.





DOBLE O ø70cm

Formed by a double ring of steel or wenge wood, combined with solid wood hands. It features ornamental metallic details that distinguish this design, creating one of Nomon's most elaborate models.

Formado por un doble aro de acero inoxidable o madera de wengué combinado con agujas de madera maciza, destaca detalles ornamentales metálicos que distinguen el conjunto, logrando uno de los modelos más elaborados de Nomon



DOBLE O NG

Polished steel rings, wenge wood hands and golden details.
A very precise work can be appreciated in the hands' detail.
Aros y agujas de madera de nogal con acabado wengué y detalles dorados.
Sus particulares agujas muestran la gran calidad del reloj.





CRIS ø80cm

Breaking with all rules and conventions, it is composed of a fiberglass minute hand mounted on a metal ring that gives this model its distinctive character. It includes metallic details down to the smallest detail.

Rompiendo con todas las reglas y convencionalismos, se compone por una aguja minutería de fibra de vidrio montada sobre un aro metálico que le da su carácter distintivo. Incorpora detalles metálicos cuidando hasta el más mínimo detalle.



CRIS G

Polished brass details and minute hand in black fiberglass with arrow in walnut wood. Detalles en latón pulido y aguja minutería de fibra de vidrio negra con punta en nogal.



CRIS N

Chromed metal details and minute hand in white fiberglass with arrow in walnut wood.
Detalles metálicos cromados y aguja minutería de fibra de vidrio blanca con punta en nogal.

Rings

TECHNICAL INFORMATION

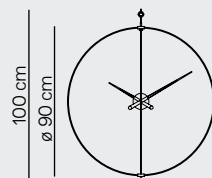

BARCELONA

Box in walnut wood / Caja en madera de nogal
 Hands in black lacquered walnut wood / Agujas en madera de nogal lacada negra
 Rings in black fiberglass / Aros en fibra de vidrio negra

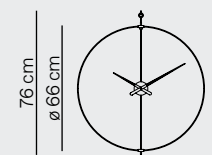

MINI BARCELONA

Box in walnut wood / Caja en madera de nogal
 Hands in black lacquered walnut wood / Agujas en madera de nogal lacada negra
 Rings in black fiberglass / Aros en fibra de vidrio negra

MINI BARCELONA G

Box in polished brass / Caja en latón pulido
 Hands in walnut wood / Agujas en madera de nogal
 Rings in black fiberglass / Aros en fibra de vidrio negra

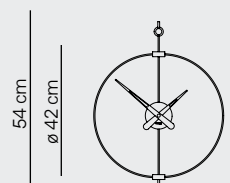

MICRO BARCELONA G

Box in polished brass / Caja en latón pulido
 Hands in walnut wood / Agujas en madera de nogal
 Rings in black fiberglass / Aros en fibra de vidrio negra

MICRO BARCELONA T

Box in graphite finished brass / Caja en latón acabado grafito
 Hands in walnut wood / Agujas en madera de nogal
 Rings in black fiberglass / Aros en fibra de vidrio negra

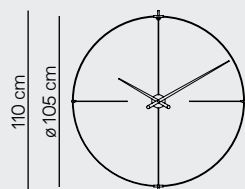

BILBAO N

Box in chromed brass / Caja en latón cromado
 Hands in black, white or wenge finish / Agujas en madera de nogal o acabada wengué
 Ring in black or white fiberglass / Aro en fibra de vidrio negra o blanca

BILBAO L

Box in chromed brass / Caja en latón cromado
 Hands in black lacquered walnut wood / Agujas en madera de nogal lacada negra
 Ring in black or white fiberglass / Aro en fibra de vidrio negra o blanca

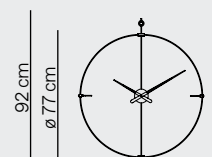

MINI BILBAO

Box in walnut wood / Caja en madera de nogal
 Hands in black lacquered walnut wood / Agujas en madera de nogal lacada negra
 Ring in black fiberglass / Aro en fibra de vidrio negra

MINI BILBAO G

Box in polished brass / Caja en latón pulido
 Hands in walnut wood / Agujas en madera de nogal
 Ring in black fiberglass / Aro en fibra de vidrio negra

Rings

TECHNICAL INFORMATION

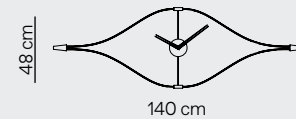

LOOK

Box in walnut wood / Caja en madera de nogal
 Hands in walnut wood / Agujas en madera de nogal
 Rings in black fiberglass / Aros en fibra de vidrio negra

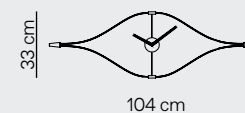

MINI LOOK N

Box in polished brass / Caja en latón pulido
 Hands and details in walnut wood / Agujas y detalles en madera de nogal
 Rings in black fiberglass / Aros en fibra de vidrio negra

MINI LOOK C

Box in polished brass / Caja en latón pulido
 Hands and details in wenge finished wood / Agujas y detalles en madera acabada wengué
 Rings in black fiberglass / Aros en fibra de vidrio negra

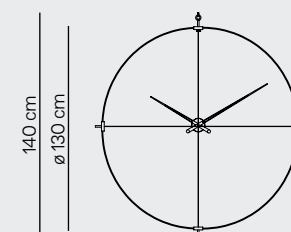

DELMORI

Box in chromed brass / Caja en latón cromado
 Hands in walnut wood or wenge finish / Agujas en madera de nogal o acabada wengué
 Rings in black fiberglass / Aros en fibra de vidrio negra

DELMORI G

Box in polished brass / Caja en latón pulido
 Hands in walnut wood or wenge finish / Agujas en madera de nogal o acabada wengué
 Rings in black fiberglass / Aros en fibra de vidrio negra

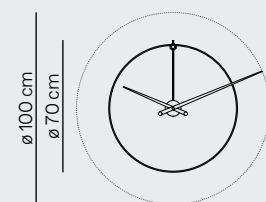

NEW ANDA

Box in chromed brass / Caja en latón cromado
 Hands in black, white or red lacquered walnut wood / Agujas en madera de nogal lacada, negra, blanca o roja
 Ring in stainless steel / Aro en acero inoxidable

NEW ANDA G

Box in polished brass / Caja en latón pulido
 Hands in walnut wood / Agujas en madera de nogal
 Ring in polished brass / Aro en latón pulido

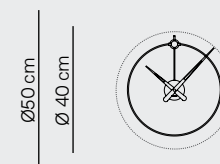

MICRO ANDA G

Box in polished brass / Caja en latón pulido
 Hands in walnut wood / Agujas en madera de nogal
 Ring in polished brass / Aro en latón pulido

MICRO ANDA T

Box in graphite finished brass / Caja en latón acabado grafito
 Hands in walnut wood / Agujas en madera de nogal
 Ring in graphite finished brass / Aro en latón acabado grafito

Rings TECHNICAL INFORMATION

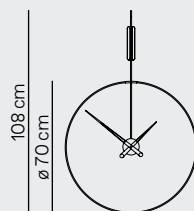

DARO

Box in polished brass / Caja en latón pulido
 Hands in walnut wood / Agujas en madera de nogal
 Ring in polished brass / Aro en latón pulido

DARO T

Box in graphite finished brass / Caja en latón acabado grafito
 Hands in walnut wood / Agujas en madera de nogal
 Ring in graphite finished brass / Aro en latón acabado grafito

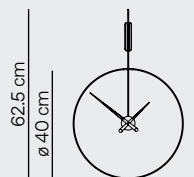

MICRO DARO G

Box in polished brass / Caja en latón pulido
 Hands in walnut wood / Agujas en madera de nogal
 Ring in polished brass / Aro en latón pulido

MICRO DARO T

Box in graphite finished brass / Caja en latón acabado grafito
 Hands in walnut wood / Agujas en madera de nogal
 Ring in graphite finished brass / Aro en latón acabado grafito

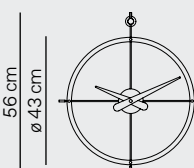

2 PUNTOS i

Box in chromed brass / Caja en latón cromado
 Hands in stainless steel / Agujas en acero inoxidable
 Rings in stainless steel / Aros en acero inoxidable

2 PUNTOS N

Box in chromed brass / Caja en latón cromado
 Hands in wenge finished wood / Agujas en madera acabada wengué
 Rings in wenge finished wood / Aros en madera acabada wengué

2 PUNTOS NG

Box in polished brass / Caja en latón pulido
 Hands in wenge finished wood / Agujas en madera acabada wengué
 Rings in wenge finished wood / Aros en madera acabada wengué

Rings TECHNICAL INFORMATION

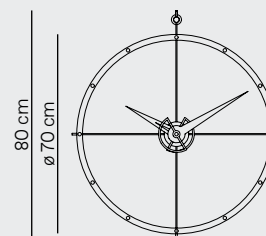

DOBLE O i

Box in chromed brass / Caja en latón cromado
 Hands in walnut wood and stainless steel / Agujas en madera de nogal y acero inoxidable
 Rings in stainless steel / Aros en acero inoxidable

DOBLE O N

Box in chromed brass / Caja en latón cromado
 Hands in wenge finished wood and chromed brass /
 Agujas en madera acabada wengué y latón cromado
 Ring in wenge finished wood / Aros en madera de acabada wengué

DOBLE O G

Box in chromed brass / Caja en latón cromado
 Hands in wenge finished wood and polished brass /
 Agujas en madera acabada wengué y latón pulido
 Rings in stainless steel / Aros en acero inoxidable

DOBLE O NG

Box in polished brass / Caja en latón pulido
 Hands in wenge finished wood and polished brass /
 Agujas en madera acabada wengué y latón pulido
 Rings in wenge finished wood / Aros en madera acabada wengué

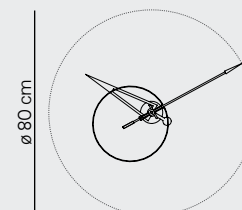

CRIS N

Box in chromed brass / Caja en latón cromado
 Hour hand in walnut wood / Aguja horaria en madera de nogal
 Minute hand in white fiberglass with the arrow in walnut /
 Aguja minuterera en fibra de vidrio blanca con punta en nogal

CRIS N

Box in polished brass / Caja en latón pulido
 Hour hand in walnut wood / Aguja horaria en madera de nogal
 Minute hand in black fiberglass with the arrow in walnut /
 Aguja minuterera en fibra de vidrio negra con punta de nogal

PENDULUM COLLECTION

CLOCKS WITH GREAT PERSONALITY AND A CONTEMPORARY DESIGN, REINTERPRETING THE CLASSIC PENDULUM CLOCK.

Relojes con gran personalidad
y con un diseño contemporáneo,
que reinterpretan el clásico reloj de péndulo.



Punto y Coma
P.110-113



Péndulo
P.114-117



Swing
P.118-119



Eslabón
P.120-123



Micro Eslabón
P.124-125



Colgante
P.126-127



PUNTO Y COMA ø37cm · L113cm

A tribute to the classic pendulum clock, characterized by the absence of accessory elements in its design. Metallic central box and hands in natural walnut or polished steel.

Un homenaje al clásico reloj de péndulo, caracterizado por la ausencia de complementos en su conjunto. Caja central metálica y agujas en nogal natural o acero pulido.



PUNTO Y COMA G

Hands and pendulum made of natural walnut wood, and polished brass details.
Agujas y péndulo en madera de nogal natural, detalles en latón pulido.





PÉNDULO ø60cm / ø74cm

Running up and down the wall, the clock is supported by a steel cable, ending in a large metal pendulum. Can be installed to wall or ceiling.

Recorriendo la pared de arriba abajo, el conjunto se sostiene mediante un cable de acero, terminando en un péndulo metálico de grandes dimensiones. Instalación a pared o techo.



PÉNDULO T

Natural walnut wood hands; graphite finish central box and pendulum.
Agujas en madera de nogal natural, caja central y péndulo acabado grafito.

CREATIVITY AND
DESIGN ARE
THE THREE
MAIN PRINCIPLES
THAT MARK
OUR PRODUCTS.

La calidad de los materiales nos relaciona con
la tradición, la verdad y la honestidad





SWING ø34cm · L80cm

This model combines the warmth of walnut wood and the elegance of the classic pendulum clock movement. Double-rod hands can be chosen in polished, or graphite finished brass.

Combinando la calidez de la madera de nogal y la elegancia del movimiento del clásico reloj de péndulo nace este modelo. Se personaliza con agujas de doble varilla de latón pulido o acabado grafito.



SWING G

Walnut finished solid wood body, hands, and pendulum in polished brass.
Cuerpo en madera maciza acabado nogal, agujas y péndulo en latón pulido.



ESLABÓN ø30cm · L68cm

Clock inspired by the design of a jewelry pendant, where the curved rod holds the marble or natural walnut plate, giving the product a subtle lightness. Awarded with a Silver Delta at the ADI-FAD Design Awards.

Reloj inspirado en el diseño de un colgante de joyería, donde la varilla curvada sostiene el plato de mármol o nogal natural dotando al producto de una sutil ligereza. Premiado con un Delta de Plata en los premios Adi Fad.



ESLABÓN WALNUT GOLD

Natural walnut wood plate with curved rod in brass finish.
Plato en madera de nogal natural con varilla curvada acabada latón.



ESLABÓN EMPERADOR MARBLE

Emperador marble plate with curved rod in brass finish.

Hands in polished brass and natural walnut. Also available in the marbles Calacatta Gold and Sahara Noir.

Presentamos el mármol Emperador, combinado con varilla curvada acabado latón. Agujas en latón pulido y nogal natural.

También disponible en mármol Calacatta Gold y Sahara Noir.

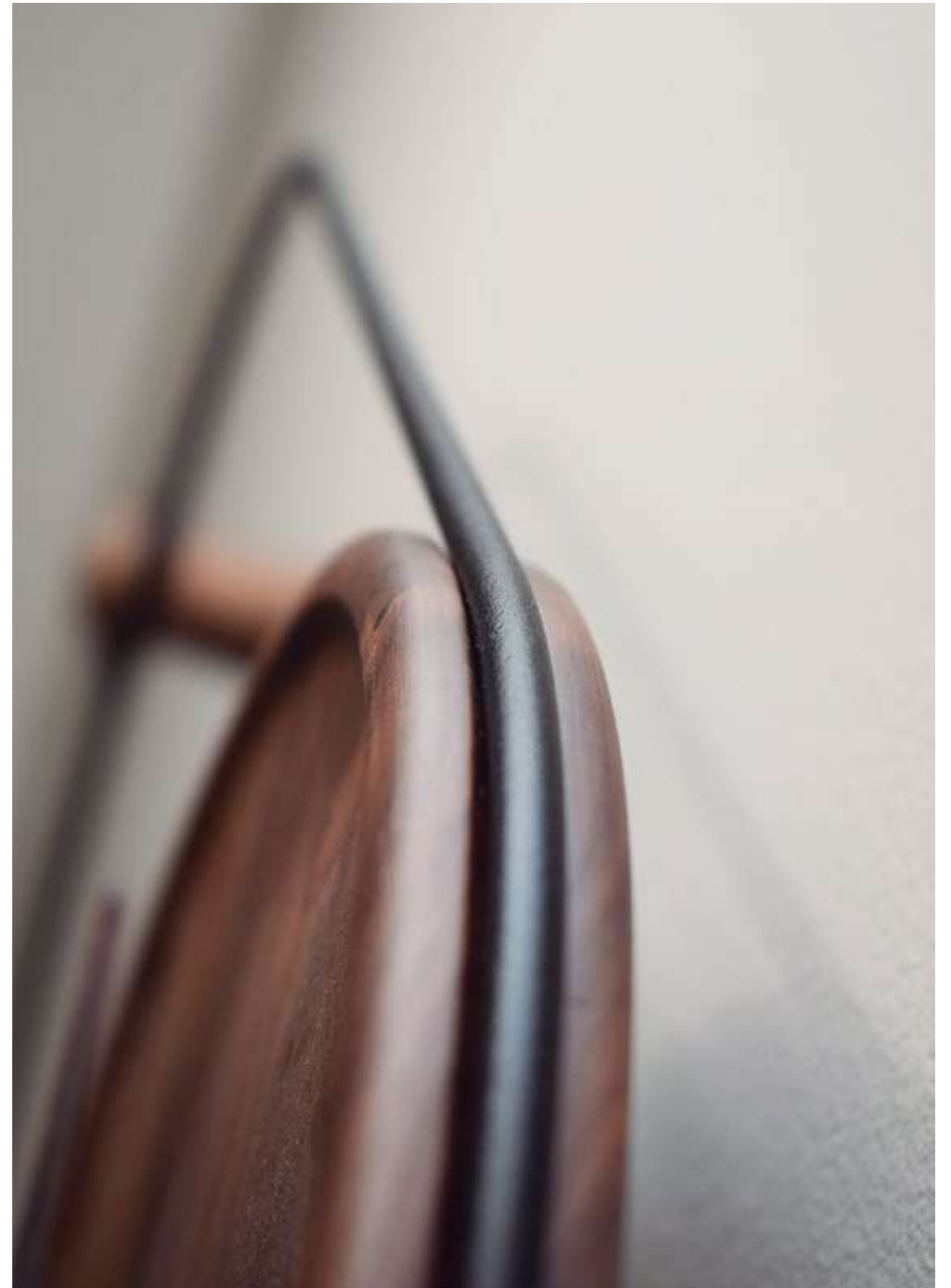



MICRO ESLABÓN ø10cm · L26,5cm

Small and versatile wall clock, it perfectly suits any space, office, bathroom, or kitchen. Combines walnut or oak pieces with metal details.

Pequeño reloj de pared muy versátil, encaja perfecto en cualquier espacio, de trabajo, baño o cocina. Combina piezas en nogal o roble con detalles metálicos.



MICRO ESLABÓN OAK

Available in natural walnut or oak finish.
Metallic details in polished brass or graphite finish.
Disponibile en madera de nogal o acabado roble.
Detalles metálicos en latón pulido o acabado grafito.



COLGANTE SAHARA NOIR MARBLE

Sahara Noir marble plate with curved rod in brass finish.
Hands made of natural walnut and black finished brass.

Plato de mármol Sahara noir con varilla curvada acabado latón.
Agujas de nogal natural y latón acabado negro.



COLGANTE ø30cm · H79cm

The sophistication of the marble suspended from the curved metal rod in brass or black finish, makes this model a jewel.
It can be installed on a wall or suspended from the

La sofisticación del mármol suspendido de la varilla metálica curvada acabada latón o negro, convierte este modelo en una joya.
Puede instalarse sobre una pared o suspendido del techo.

Pendulums TECHNICAL INFORMATION

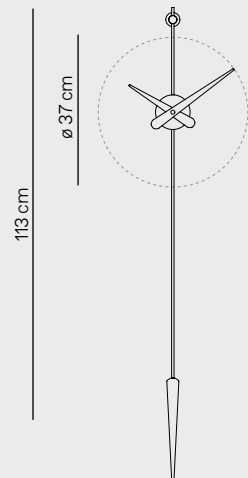

PUNTO Y COMA N

Box in chromed brass / Caja en latón cromado
Hands in walnut wood / Agujas en madera de nogal
Pendulum in walnut wood / Péndulo en madera de nogal

PUNTO Y COMA i

Box in chromed brass / Caja en latón cromado
Hands in stainless steel / Agujas en acero inoxidable
Pendulum in chromed brass / Péndulo en latón cromado

PUNTO Y COMA T

Box in graphite finished brass / Caja en latón acabado grafito
Hands in walnut wood / Agujas en madera de nogal
Pendulum in walnut wood / Péndulo en madera de nogal

PUNTO Y COMA G

Box in polished brass / Caja en latón pulido
Hands in walnut wood / Agujas en madera de nogal
Pendulum in walnut wood / Péndulo en madera de nogal

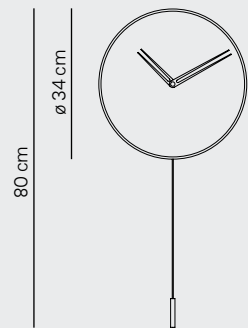

SWING i

Body in solid wood with walnut finish / Cuerpo en madera maciza con acabado nogal
Hands in chromed brass / Agujas en latón cromado
Pendulum in chromed brass / Péndulo en latón cromado

SWING G

Body in solid wood with walnut finish / Cuerpo en madera maciza con acabado nogal
Hands in polished brass / Agujas en latón pulido
Pendulum in polished brass / Péndulo en latón pulido

ESLABÓN

Plate in marble Sahara noir, Emperador, Calacatta Gold or walnut wood
/ Plato en mármol Sahara noir, Emperador, Calacatta Gold o nogal
Hour hand in polished brass or black finish and minute hand in walnut wood
/ Aguja horaria en latón pulido o acabado negro y aguja minuterera en madera de nogal
Metal ring in brass or black finish / Metal acabado latón o negro

MICRO ESLABÓN G

Box in walnut or oak finished wood / Caja en madera de nogal o acabado roble
Hands in walnut or oak finished wood and polished brass / Agujas en madera de nogal
o acabado roble y latón pulido
Ring in polished brass / Aro en latón pulido

MICRO ESLABÓN T

Box in walnut or oak finished wood / Caja en madera de nogal o acabado roble
Hands in walnut or oak finished wood and graphite finished brass /
Agujas en madera de nogal o acabado roble y latón acabado grafito
Ring in graphite finished brass / Aro en latón acabado grafito

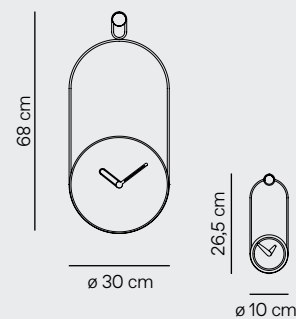

Pendulums TECHNICAL INFORMATION

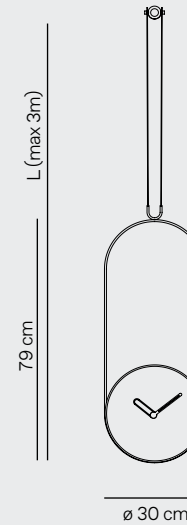

COLGANTE

Plate in marble Sahara noir, Emperador, Calacatta Gold or walnut wood
/ Plato en mármol Sahara noir, Emperador, Calacatta Gold o nogal
Hour hand in polished brass or black finish and minute hand in walnut wood
/ Aguja horaria en latón pulido o acabado negro y aguja minuterera en madera de nogal
Metal ring in brass or black finish / Metal acabado latón o negro

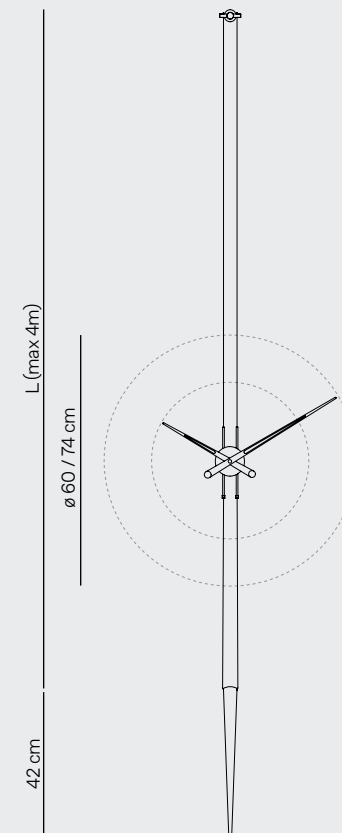

PÉNDULO i ø60cm

Box in chromed brass / Caja en latón cromado
Hands in stainless steel / Agujas en acero inoxidable
Pendulum in chromed brass / Péndulo en latón cromado

PÉNDULO G ø74cm

Box in polished brass / Caja en latón pulido
Hands in walnut wood / Agujas en madera de nogal
Pendulum in polished brass / Péndulo en latón pulido

PÉNDULO T ø74cm

Box in graphite finished brass / Caja en latón acabado grafito
Hands in walnut wood / Agujas en madera de nogal
Pendulum in graphite finished brass / Péndulo en latón acabado grafito

TIME SIGNALS COLLECTION

SIMPLE, VERSATILE, AND SOBER CLOCKS.
THE ELEGANCE LIES IN THE LIGHTNESS
OF THEIR TIME SIGNALS, DRAWING
AN IMAGINARY CIRCLE ON THE WALL.

Relojes de líneas sencillas, versátiles y sobrios.
La elegancia de estos modelos radica en la
ligereza de sus señales horarias, que dibujan
un círculo imaginario en la pared.



Rodon Series
P.132-134



Puntos Suspensivos
P.135



Sunset
P.136-137



Tacón
P.138-141



Merlín Series
P.142-147



Mixto
P.148-149



RODÓN ø70cm / ø74cm

Simplicity is the essence of this discreet proposal that once installed, acquires its own personality. The 12 round hour markers are metallic, and the hands are available in steel or natural walnut.

La sencillez es la esencia de esta propuesta discreta que una vez instalada, adquiere personalidad propia. Las 12 señales horarias son metálicas y redondas y las agujas en metal o nogal natural.





RODÓN MINI ø50cm

Suitable to any space, it preserves the concept of simplicity. This reduced version of the Rodon clock stands out for its walnut hands lacquered in black, white or red.

Adaptable en cualquier ambiente y conservando el concepto de sencillez, la versión reducida del reloj Rodón destaca por sus agujas de nogal lacadas en negro, blanco o rojo.



PUNTOS SUSPENSIVOS ø50cm

The classic industrial style wall clock, crafted with attention to every detail. Its steel hands are available in black, red, or white.

El clásico reloj de pared de estilo industrial, elaborado cuidando hasta el más mínimo detalle. Sus agujas de acero están disponibles en negro, rojo o blanco.

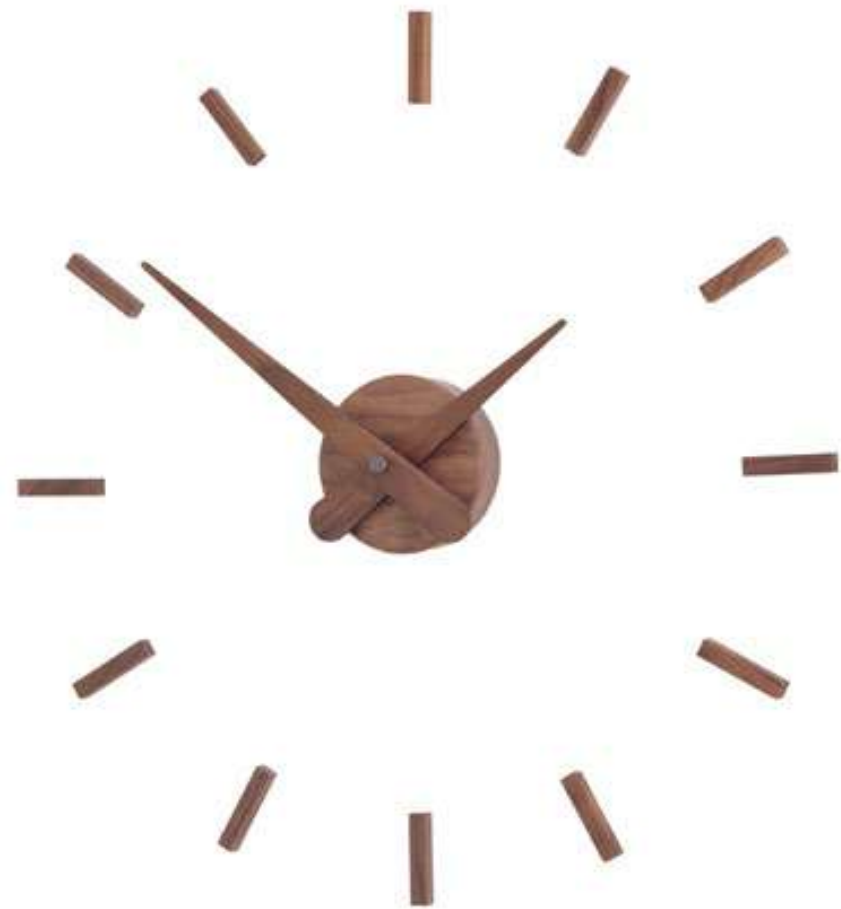

SUNSET ø50cm

The wood of the extended hour markers adds warmth to the wall and the easy installation with adhesive brings versatility to the whole design.

La madera de las marcas horarias, prolongadas, aporta calidez sobre la pared y su fácil instalación con adhesivo, aporta versatilidad al conjunto.



SUNSET i

Available with a central box in chromed metal, providing light and distinction.
Disponible con caja central cromada que le aporta un punto de luz y distinción.



TACÓN ø74cm/ ø100cm

Avant-garde industrial design. The lacquered hands (in black, red, or white) surpass the hour marks, becoming the main character. Its wall installation can be adjusted to the required measurements.

Diseño industrial vanguardista. Las agujas lacadas (en negro, rojo o blanco) sobrepasan las marcas horarias, convirtiéndose en las protagonistas. Su instalación a pared, puede ajustarse a las medidas solicitadas.



TACÓN i

The wall installation can be adjusted to the diameter requested by the customer. We send an installation template in the required size.

La instalación a pared puede ajustarse a la medida que solicite el cliente. Enviamos una plantilla de instalación con las medidas requeridas.

WE RECOVER TIMELESS DESIGNS, BRINGING A RENEWED AESTHETIC

Recuperamos diseños atemporales,
aportando una estética renovada.



TACÓN G

Central box and time signals in polished
brass, hands in walnut wood.

Caja central y señales horarias en latón pulido,
agujas en madera de nogal.



MERLÍN G

Central box and time signals in polished brass and walnut, hands in natural walnut.
Caja central y señales horarias en latón pulido y nogal, agujas en madera de nogal.



MERLÍN ø110cm / ø125cm / ø155cm

Wall clock with 12 special hour markers, inspired by the magic wand of the wizard Merlin. Combining wood and metal, the elegant result of this design lies in the simplicity of its elements.

Reloj con 12 particulares señales horarias, inspiradas en la varita mágica del mago Merlín. Combinando madera y metal, el elegante resultado del conjunto radica en la simplicidad de sus elementos.



MERLÍN T

Central box and time signals in graphite
finished brass, hands in walnut wood.
Caja central y señales horarias en latón
acabado grafito y agujas en madera de nogal.

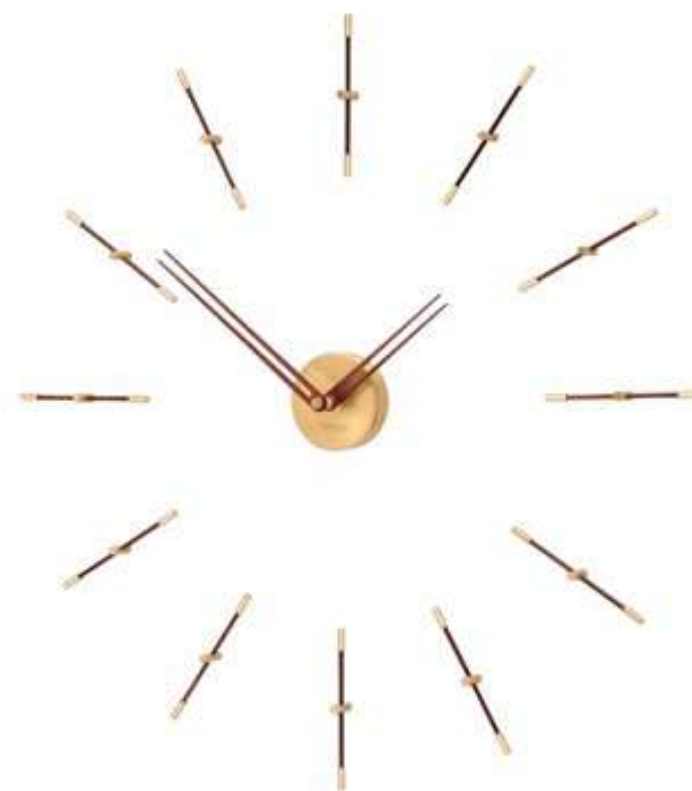

MINI MERLÍN ø70cm

Clock with 12 time signals that combine metallic details with natural walnut or wenge. Its hands stand out, reminiscent of the shape of a tuning fork, matching the hour markers during the passing of the hours.

Reloj con 12 señales horarias que combinan detalles metálicos con nogal natural o wengué. Destacan sus agujas que recuerdan a la forma de un diapasón, concordando con las marcas horarias durante el paso de las horas



MIXTO ø110cm / ø125cm / ø155cm

This bold and complete model, perfect for any room, is born out of the combination of the characteristic round pieces of the Rodon collection and the Merlin time signals.

Combinando las características piezas redondeadas de la colección Rodón con las varillas de la serie Merlin, nace este modelo atrevido y completo, perfecto para cualquier estancia.



MIXTO i

Stainless steel hands painted in black.
Box in chromed brass.
Agujas en acero pulido pintadas en negro.
Caja central de latón cromado.

Time Signals TECHNICAL INFORMATION

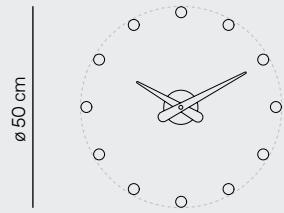

ø 50 cm

RODON MINI L

Box in **chromed brass** / Caja en latón cromado
 Hands in **black, white or red lacquered walnut wood** / Agujas en madera de nogal acada negra, blanca o roja
 TS in **chromed brass** / SH en latón cromado

*12 time signals (12TS)
 *12 señales horarias (12SH)

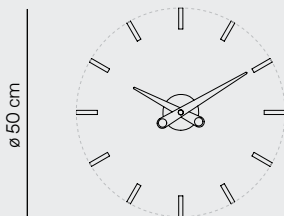

ø 50 cm

PUNTOS SUSPENSIVOS

Box in **chromed brass** / Caja en latón cromado
 Hands in **polished steel, or painted in black, white, or red** / Agujas en acero inoxidable o pintadas en negro, blanco o rojo
 TS in **chromed brass** / SH en latón cromado

*12 time signals (12TS)
 *12 señales horarias (12SH)

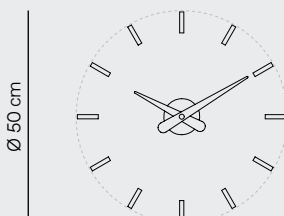

ø 50 cm

SUNSET i

Box in **chromed brass** / Caja en latón cromado
 Hands in **walnut wood** / Agujas en madera de nogal
 TS in **walnut wood** / SH en madera de nogal

SUNSET N

Box in **walnut wood** / Caja en madera de nogal
 Hands in **walnut wood** / Agujas en madera de nogal
 TS in **walnut wood** / SH en madera de nogal

SUNSET T

Box in **graphite finished brass** / Caja en latón acabado grafito
 Hands in **walnut wood** / Agujas en madera de nogal
 TS in **walnut wood** / SH en madera de nogal

*12 time signals (12TS)
 *12 señales horarias (12SH)



ø 70 cm

RODON i ø 70cm

Box in **chromed brass** / Caja en latón cromado
 Hands in **polished steel, or painted in black, white, or red** / Agujas en acero inoxidable o pintadas en negro, blanco o rojo
 TS in **chromed brass** / SH en latón cromado

RODON T ø 70cm

Box in **graphite finished brass** / Caja en latón acabado grafito
 Hands in **graphite finished steel** / Agujas en acero acabado grafito
 TS in **graphite finished brass** / SH en latón acabado grafito

Time Signals TECHNICAL INFORMATION

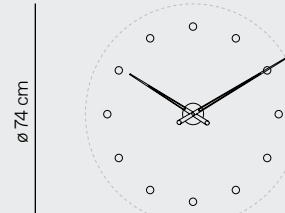

ø 74 cm

RODON G ø 74cm

Box in **polished brass** / Caja en latón pulido
 Hands in **walnut or wenge finish** / Agujas en madera de nogal o acabada wengué
 TS in **polished brass** / SH en latón pulido

*12 time signals (12TS)
 *12 señales horarias (12SH)

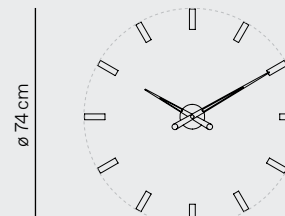

ø 74 cm

TACÓN i ø 74cm

Box in **chromed brass** / Caja en latón cromado
 Hands in **polished steel, or painted in black, white, or red** / Agujas en acero inoxidable o pintadas en negro, blanco o rojo
 TS in **chromed brass** / SH en latón cromado

*12 time signals (12TS)
 *12 señales horarias (12SH)



ø 100 cm

TACÓN L ø 100cm

Box in **chromed brass** / Caja en latón cromado
 Hands in **black, white or red lacquered walnut wood** / Agujas en madera de nogal lacada negra, blanca o roja
 TS in **chromed brass** / SH en latón cromado

TACÓN G ø 100cm

Box in **polished brass** / Caja en latón pulido
 Hands in **walnut or wenge finish** / Agujas en madera de nogal o acabada wengué
 TS in **polished brass** / SH en latón pulido

TACÓN T ø 100cm

Box in **graphite finished brass** / Caja en latón acabado grafito
 Hands in **walnut or wenge finish** / Agujas en madera de nogal o acabada wengué
 TS in **graphite finished brass** / SH en latón acabado grafito

*The clock can be ordered with 4 time signals (4TS)
 *Posibilidad de pedir el reloj con 4 señales horarias (4SH)

Time Signals TECHNICAL INFORMATION

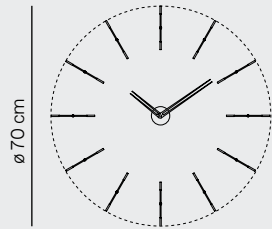

MINI MERLÍN N

Box in **chromed brass** / Caja en latón cromado
 Hands in **walnut or wenge finish** / Agujas en madera de nogal o acabada wengué
 TS in **chromed brass and walnut or wenge finish** /
 SH en latón cromado y madera de nogal o acabada wengué

MINI MERLÍN G

Box in **polished brass** / Caja en latón pulido
 Hands in **walnut or wenge finish** / Agujas en madera de nogal o acabada wengué
 TS in **polished brass and walnut or wenge finish** /
 SH en latón pulido y madera de nogal o acabada wengué

MINI MERLÍN T

Box in **graphite finished brass** / Caja en latón acabado grafito
 Hands in **walnut or wenge finish** / Agujas en madera de nogal o acabada wengué
 TS in **graphite finished brass and walnut wood or wenge finish** /
 SH en latón acabado grafito y madera de nogal o acabada wengué

*12 time signals (12TS)
 *12 señales horarias (12SH)

*The clock can be ordered with 4 time signals (4TS)
 *Posibilidad de pedir el reloj con 4 señales horarias (4SH)

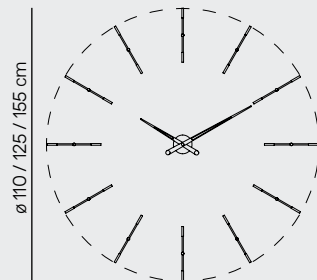

MERLÍN N ø125/155cm

Box in **chromed brass** / Caja en latón cromado
 Hands in **walnut or wenge finish** / Agujas en madera de nogal o acabada wengué
 TS in **chromed brass and walnut or wenge finish** /
 SH en latón cromado y madera de nogal o acabada wengué

MERLÍN G ø125/155cm

Box in **polished brass** / Caja en latón pulido
 Hands in **walnut or wenge finish** / Agujas en madera de nogal o acabada wengué
 TS in **polished brass and walnut wood or wenge finish** /
 SH en latón pulido y madera de nogal o acabada wengué

MERLÍN T ø125/155cm

Box in **graphite finished brass** / Caja en latón acabado grafito
 Hands in **walnut or wenge finish** / Agujas en madera de nogal o acabada wengué
 TS in **graphite finished brass and walnut or wenge wood** /
 SH en latón acabado grafito y en madera de nogal o acabada wengué

MERLÍN i ø110cm

Box in **chromed brass** / Caja en latón cromado
 Hands in **polished steel, or painted in black, white, or red** / Agujas en acero inoxidable o pintadas en negro, blanco o rojo
 TS in **chromed brass or painted in black, white, or red** /
 SH en latón cromado o pintadas en negro, blanco o rojo

*12 time signals (12TS)
 *12 señales horarias (12SH)

*The clock can be ordered with 4 time signals (4TS)
 *Posibilidad de pedir el reloj con 4 señales horarias (4SH)

Time Signals TECHNICAL INFORMATION

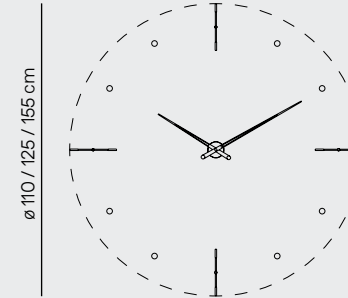

MIXTO N ø125/155cm

Box in **polished brass** / Caja en latón pulido
 Hands in **walnut or wenge finish** / Agujas en madera de nogal o acabada wengué
 TS in **polished brass and walnut or wenge finish** /
 SH en latón pulido y madera de nogal o acabada wengué

MIXTO G ø125/155cm

Box in **polished brass** / Caja en latón pulido
 Hands in **walnut or wenge finish** / Agujas en madera de nogal o acabada wengué
 TS in **polished brass and walnut or wenge finish** /
 SH en latón pulido y madera de nogal o acabada wengué

MIXTO i ø110cm

Box in **chromed brass** / Caja en latón cromado
 Hands in **polished steel, or painted in black, white, or red** /
 Agujas en acero inoxidable o pintadas en negro, blanco o rojo
 TS in **chromed brass or painted in black, white, or red** /
 SH en latón cromado o pintadas en negro, blanco o rojo

*12 time signals (12TS)
 *12 señales horarias (12SH)

TABLE / FLOOR

COLLECTION OF SCULPTURAL, AVANT-GARDE
CLOCKS, WITH GREAT CHARACTER.
UNIQUE PIECES FOR DESIGN LOVERS.

Colección de relojes escultóricos,
vanguardistas y con gran carácter.
Piezas singulares para los amantes del diseño.



Aire
P.156-157



Mini Aire
P.158-159



Omega
P.160-161



Puntero
P.162-163



Pisa
P.164-165



AIRE ø50cm · L55cm

Keeping the essence of the iconic ring clocks that represent the brand, this model includes a stand to be displayed on a console. It combines walnut-finished wood with chromed metal details.

Manteniendo la misma esencia de los icónicos aros representativos de la marca, este modelo incorpora un soporte para exponerse sobre un mueble tipo consola. Combina la madera acabado nogal con detalles metálicos cromados.



AIRE G

Central box and top rod in polished brass.
Latón pulido para la caja central y varilla superior.



MINI AIRE ø26cm · H30cm

Smaller version of Aire clock, formed by a double ring of black fiberglass, that combines pieces in walnut with metallic details.

Versión reducida del modelo Aire, formado por un doble aro de fibra de vidrio negra, que combina piezas en nogal con detalles dorados.



OMEGA ø43cm · L40cm

Two large polished steel rings, assembled together by means of three small rods, rest on two metal bases, forming a harmonious clock with its own entity.

Dos grandes aros de acero pulido, ensamblados entre sí mediante tres pequeñas varillas, reposan sobre bases metálicas, formando un conjunto armónico con identidad propia.





PUNTERO ø74cm · H94cm

Model of great visual impact, where the clock rests on a metal base and a solid wood body, achieving a total balance of the piece.

Modelo de gran impacto visual, donde el conjunto se apoya sobre una base metálica y un cuerpo de madera maciza, logrando un equilibrio total de la pieza.



PUNTERO L

Hands and body in black lacquered walnut wood. Chromed brass central box and base.
Agujas y cuerpo en madera de nogal lacado negro. Caja central y base en latón cromado.



PISA ø74cm · H150cm

Rising from the ground with a slender solid wood body that forms a slight diagonal, the Pisa clock stands out for its elegance, enhanced by chromed or polished brass details.

Elevándose desde el suelo con un estilizado cuerpo de madera maciza que forma una ligera dirección diagonal, se constituye el reloj Pisa, que destaca por su elegancia favorecida por sus detalles metálicos de latón cromado o pulido.



PISA G

Natural walnut wood hands and body.
Polished brass central box and base.
Agujas y cuerpo en madera de nogal natural.
Caja central y base en latón pulido.

Table TECHNICAL INFORMATION

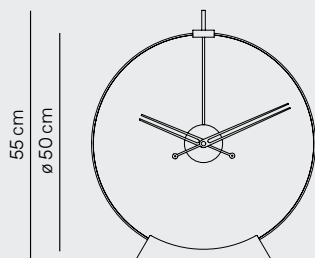

AIRE ø50cm · L 55cm
 Box in stained ash wood / Caja en madera de fresno teñida
 Hands in stained ash wood / Agujas en madera de fresno teñida
 Rings in black fiberglass / Aros en fibra de vidrio negra

AIRE G ø50cm · L 55cm
 Box in polished brass / Caja en latón pulido
 Hands in stained ash wood / Agujas en madera de fresno teñida
 Rings in black fiberglass / Aros en fibra de vidrio negra

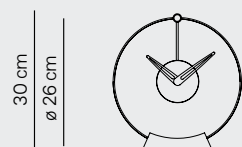

MINI AIRE ø26cm · H30cm
 Box in polished brass / Caja en latón pulido
 Hands in walnut wood / Agujas en madera de nogal
 Rings in black fiberglass / Aros en fibra de vidrio negra

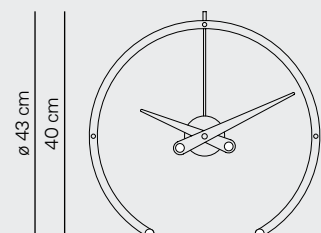

OMEGA i ø43cm · L 40cm
 Box in chromed brass / Caja en latón cromado
 Hands in stainless steel / Agujas en acero inoxidable
 Rings in stainless steel / Aros en acero inoxidable

OMEGA G ø43cm · L 40cm
 Box in polished brass / Caja en latón pulido
 Hands in stainless steel and polished brass / Agujas en acero y latón pulido
 Ring in stainless steel / Aro en acero inoxidable

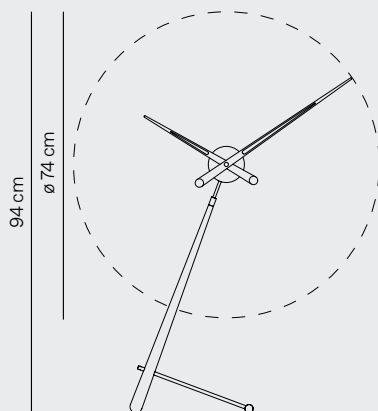

PUNTERO G ø74cm · L 94cm
 Box in polished brass / Caja en latón pulido
 Hands in walnut or wenge finish / Agujas en madera de nogal o acabado wengué

PUNTERO L ø74cm · L 94cm
 Box in chromed brass / Caja en latón cromado
 Hands in black, white or red lacquered walnut wood / Agujas en madera de nogal lacada negra, blanca o roja

PUNTERO N ø74cm · L 94cm
 Box in chromed brass / Caja en latón cromado
 Hands in walnut or wenge finish / Agujas en madera de nogal o acabado wengué

PUNTERO T ø74cm · L 94cm
 Box in graphite finished brass / Caja en latón acabado grafito
 Hands in walnut or wenge finish / Agujas en madera de nogal o acabado wengué

Table TECHNICAL INFORMATION

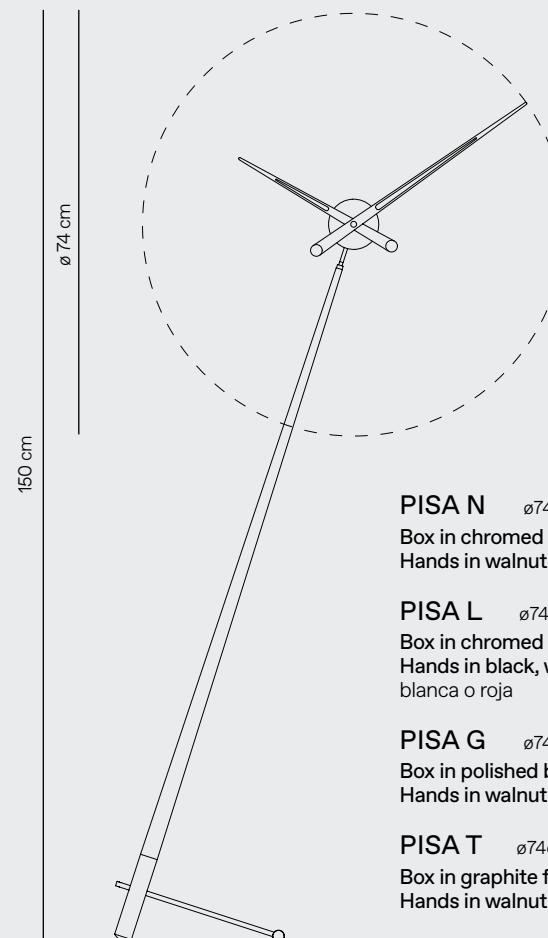

PISA N ø74cm · H150cm
 Box in chromed brass / Caja en latón cromado
 Hands in walnut or wenge finish / Agujas en madera de nogal o acabado wengué

PISA L ø74cm · H150cm
 Box in chromed brass / Caja en latón cromado
 Hands in black, white or red lacquered walnut wood / Agujas en madera de nogal lacada negra, blanca o roja

PISA G ø74cm · H150cm
 Box in polished brass / Caja en latón pulido
 Hands in walnut or wenge finish / Agujas en madera de nogal o acabado wengué

PISA T ø74cm · H150cm
 Box in graphite finished brass / Caja en latón acabado grafito
 Hands in walnut or wenge finish / Agujas en madera de nogal o acabado wengué

ÁTOMO COLLECTION

ÁTOMO CLOCKS, WHOSE DESIGN REFLECTS CREATIVITY
WITH A DEEP SENSE OF REFINEMENT, DRESS UP THE
CORNERS OF EVERY TABLE, BRINGING UP LIGHT AND STYLE.

Los relojes Átomo, cuyo diseño refleja creatividad
con un profundo sentido del refinamiento, visten los
rincones de mesas y mesitas, aportando luz y estilo.



Átomo
P.170-175



Mini Puntero
P.176-179



Nene
P.180-181



Nena
P.180-181

OUR DESIGN
REFLECTS
CREATIVITY WITH
A GREAT SENSE
OF REFINEMENT

Nuestro diseño refleja creatividad
con un profundo sentido del refinamiento





ÁTOMO ø10cm

Small and charming, this reduced sized model is a pure and refined design. Its natural walnut body and its finishes in polished or graphite finished brass fit well both in its table and wall versions.

Pequeño y coqueto, este modelo de reducido tamaño, es un diseño puro y refinado. Su cuerpo en madera de nogal natural y sus acabados en latón pulido o grafito encajan tanto en versión pared como en sobremesa.





MINI PUNTERO ø10cm · H26cm

26 cm high and with a diameter of 10cm. Its body and hands are made in natural walnut, with a metallic central box.

Reloj de ø10cm y 26cm de altura, con un cuerpo y agujas de nogal natural y frontal metálico.



MINI PUNTERO T

Central box and base in graphite finish.
Frontal y base en latón acabado grafito.





NENE & NENA ø10cm H22cm

Nomon's symbolic characters are born, characteristic for combining the brand's distinctive materials, American walnut, or ash in oak finish, with metallic details.

Nacen los personajes simbólicos de Nomon, característicos por combinar los materiales distintivos de la marca; Nogal americano o fresno acabado roble con detalles metálicos.

Atomo TECHNICAL INFORMATION

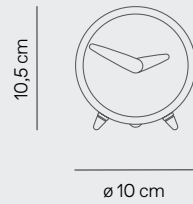

ÁTOMO SOBREMESA G ø10cm · H10,5cm

Box in walnut wood and polished brass /
Caja en madera de nogal y latón pulido
Hands in walnut wood / Agujas en madera de nogal

ÁTOMO SOBREMESA T ø10cm · H10,5cm

Box in walnut wood and graphite finished brass /
Caja en madera de nogal y metal acabado grafito
Hands in walnut wood / Agujas en madera de nogal



ÁTOMO PARED G ø10cm

Box in walnut wood and polished brass /
Caja en madera de nogal y latón pulido
Hands in walnut wood / Agujas en madera de nogal

ÁTOMO PARED T ø10cm

Box in walnut wood and graphite finished brass /
Caja en madera de nogal y metal acabado grafito
Hands in walnut wood / Agujas en madera de nogal

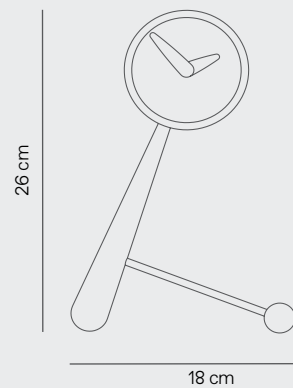

MINI PUNTERO G W18cm · H26cm

Box in walnut wood and polished brass /
Caja en madera de nogal y latón pulido
Hands in walnut wood / Agujas en madera de nogal

MINI PUNTERO T W18cm · H26cm

Box in walnut wood and graphite finished brass /
Caja en madera de nogal y metal acabado grafito
Hands in walnut wood / Agujas en madera de nogal

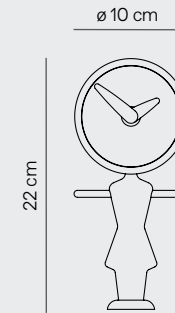

NENA ø10cm · H22cm

Box in walnut or oak finished wood and polished brass /
Caja en madera de nogal o acabado roble y latón pulido
Hands and body in walnut or oak wood /
Agujas y cuerpo en madera de nogal o roble
Arms in polished brass / Brazos en latón pulido

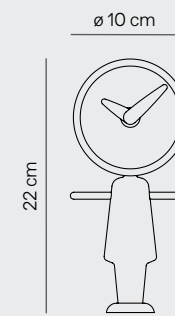

NENE ø10cm · H22cm

Box in walnut or oak finished wood and polished brass /
Caja en madera de nogal o acabado roble y latón pulido
Hands and body in walnut or oak wood /
Agujas y cuerpo en madera de nogal o roble
Arms in polished brass / Brazos en latón pulido

MARBLE COLLECTION

MARBLE IS THE MAIN CHARACTER OF THIS COLLECTION. THE NATURAL STONE, COMBINED WITH THE NATURAL WALNUT AND POLISHED BRASS HANDS, ELEVATES THESE MODELS TO THE CATEGORY OF SCULPTURE.

Esta colección tiene como protagonista principal el mármol, que unido a unas agujas de nogal y latón pulido se eleva a la categoría de escultura.



Bari S
P186-187



Bari M
P188-189



BARI S SAHARA NOIR

Plate in Sahara Noir marble, with black, orange, and white veins.
Plato de mármol Sahara con un vetado negro, naranja y blanco.



BARI S ø24cm

Marble is the main protagonist of this design,
providing elegance, beauty and neatness to the whole.
Polished brass and natural walnut hands.

Diseño en el que el mármol es el protagonista,
aportando elegancia, belleza y pulcritud al conjunto.
Agujas en latón pulido y nogal natural.



BARI M ø32cm

Larger version of the Bari S, which keeps combining a marble front plate and hands in polished brass and natural walnut.

Versión ampliada del Bari S, que sigue combinando un plato frontal de mármol y agujas en latón pulido y nogal natural.



BARI M SAHARA NOIR

The wooden turning separates the front from the wall, creating a visual game that simulates that the object levitates, achieving the perfect contrast between strength and lightness. Hands in natural walnut and brass in black finish.

El torneado de madera separa el frontal de la pared, creando un juego visual que simula que el objeto levita, consiguiendo el contraste perfecto entre fuerza y ligereza. Agujas de nogal natural y latón acabado negro.

Marble

TECHNICAL INFORMATION

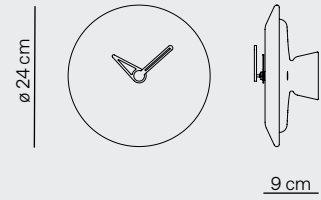

BARI S EMPERADOR ø24cm

Plate in marble Emperador/ Plato en mármol Emperador
Hands in polished brass and walnut solid wood / Agujas en latón pulido y madera de nogal

BARI S SAHARA NOIR ø24cm

Plate in marble Sahara Noir/ Plato en mármol Sahara Noir
Hands in polished brass and walnut solid wood / Agujas en latón pulido y madera de nogal



BARI M EMPERADOR ø32cm

Plate in marble Emperador/ Plato en mármol Emperador
Hands in polished brass and walnut solid wood / Agujas en latón pulido y madera de nogal

BARI M SAHARA NOIR ø32cm

Plate in marble Sahara Noir/ Plato en mármol Sahara Noir
Hands in polished brass and walnut solid wood / Agujas en latón pulido y madera de nogal

OJ CLOCK

OJ IS A CLASSIC DESIGN THAT HAS REVOLUTIONIZED THE WALL CLOCK CONCEPT. DUE TO ITS MINIMALIST AND CONTEMPORARY STYLE AND ITS WIDE RANGE OF COLORS, THIS CLOCK ADAPTS TO ALL ENVIRONMENTS, BOTH AT HOME AND CONTRACT SPACES, EXPOSING AN ORIGINAL DESIGN AVAILABLE TO EVERYONE.

OJ es un clásico del diseño que ha revolucionado el concepto de reloj de pared. Debido a su estilo minimalista y contemporáneo y su amplia gama de colores, se adapta a cualquier espacio, tanto de hogar como de contract, conformando un diseño original al alcance de todos.



	
Black RAL 9005	Pumpkin RAL 6006
	
Grey RAL 4007	Mustard RAL 4570
	
Silver RAL 3002	Pink RAL 9018
	
Red RAL 3008	Blue RAL 8060
	
White RAL 3002	Green RAL 2002

COLOR CONCEPT The clock that never goes out of style. A classic staple of the Nomon catalogue that represented one of its earliest successes. Made popular by the historic Vinçon store in Barcelona, its timelessness has ensured that it has survived the passage of time with fame and glory. It is one of the brand's most versatile pieces, available in ten colours, with numbers or dots and in two sizes.

CONCEPTO DE COLOR El reloj que nunca pasa de moda. Un clásico básico del catálogo de Nomon que representó uno de sus primeros éxitos. Popularizado por la histórica tienda Vinçon de Barcelona, su atemporalidad ha hecho que sobreviva al paso del tiempo con fama y gloria. Es una de las piezas más versátiles de la marca, disponible en diez colores, con números o puntos y en dos tamaños.



OJ CLOCK ø80cm

12 time signals manufactured in polystyrene.
Available in 10 colors.

12 señales horarias fabricadas en poliestireno.
Disponible en 10 colores





OJ CLOCK MINI ø50cm

12 time signals manufactured in polystyrene.
Available in 10 colours.

12 señales horarias fabricadas en poliestireno.
Disponibile en 10 colores.

PUN COLLECTION

NOMON INTRODUCES A COLLECTION CHARACTERIZED BY THE PRESENCE OF SIMPLE ELEMENTS RADIATING PERSONALITY AND ORIGINALITY, AND BRINGING IN FINISHES WITH A MORE YOUTHFUL AIR. THE AESTHETICS, AS ALWAYS, REMAINS IMPECCABLE, PAYING ATTENTION AND IMPORTANCE TO EACH AND EVERY DETAIL.

Nomon introduce una colección caracterizada por la presencia de elementos simples que desprenden personalidad y originalidad incorporando acabados de aire más juvenil. La estética, como siempre, permanece impoluta, prestando atención e importancia en todos y cada uno de los detalles.



Pico
P.202-207



Punta
P.208-211



Nano
P.212-215



PICO ø40cm

Avant-garde design with a nordic air, which combines walnut wood or oak finished wood with black and white colours.

Diseño vanguardista con aires nórdicos, que combina madera de nogal o acabado roble con colores negros y blancos.





PICO WHITE OAK

White central box, hands in oak finished wood and fiberglass ring.
Caja central de color blanco, agujas de madera acabado roble y aro de fibra de vidrio.





PICO BLACK WALNUT

Black central box, hands in American walnut wood and fiberglass ring.
Caja central de color negro, agujas de madera nogal americano y aro de fibra de vidrio.



PUNTA BLACK OAK

Black central box, hands and pendulum made of oak finished ash wood.
Caja central de color negro, agujas y péndulo de madera acabada roble.



PUNTA ø28cm · H63cm

Homage to the classic pendulum clock with a renewed aesthetic.
Combines walnut wood or oak finished wood with black or white fiberglass.

Homenaje al clásico reloj de péndulo con una estética renovada.
Combina madera de nogal o acabado roble con fibra de vidrio negra o blanca.



PUNTA WHITE OAK

White central box, hands and pendulum in oak finished ash wood.
Caja central de color blanco, agujas y péndulo de madera acabada roble.





NANO ø28cm

Clock which combines walnut or oak finished wood with black or white colors.

Reloj que combina madera de nogal o acabado roble con colores negros y blancos.

CUSTOM MADE

NOMON OFFERS THE POSSIBILITY
TO CUSTOMIZE THE CLOCKS USING NUMBERS
AND TIME SIGNALS WITH DIFFERENT FINISHES.

Nomon ofrece la posibilidad de personalizar
los relojes mediante el uso de números
y señales horarias de diferentes acabados.



Axioma
P. 220-221



Numbers
P.222-223



AXIOMA

THE HEART OF ALL OUR CLOCKS, AVAILABLE IN DIFFERENT MATERIALS AND DIMENSIONS. A SIMPLE WAY TO CREATE YOUR OWN CLOCK BY CUSTOMIZING THE TIME SIGNALS.

El corazón de todos nuestros relojes, disponible en diferentes materiales y dimensiones. Una forma sencilla de crear su propio reloj personalizando las señales horarias.





NUMBERS

NOMON CLOCKS CAN ALSO BE CUSTOMIZED WITH NUMBERS IN STEEL, WALNUT WOOD, OR WHITE, BLACK, OR RED METHACRYLATE.

En esta ocasión tenemos la opción de personalizar el reloj con números en acero, madera de nogal o metacrilato blanco, negro o rojo.



Custom Made TECHNICAL INFORMATION



AXIOMA i ø60 cm
Box in chromed brass /
Caja en latón cromado

Hands in polished steel, or painted in black, white, or red /
Agujas en acero pulido o pintadas en negro, blanco o rojo



AXIOMA MINI i ø37 cm
Box in chromed brass /
Caja en latón cromado

Hands in polished steel, or painted in black, white, or red /
Agujas en acero pulido o pintadas en negro, blanco o rojo



AXIOMA N ø74 cm / 100cm

Box in chromed brass /
Caja en latón cromado

Hands in walnut or wenge wood /
Agujas en madera de nogal o wengué



AXIOMA MINI N ø37 cm

Box in chromed brass /
Caja en latón cromado

Hands in walnut or wenge wood /
Agujas en madera de nogal o wengué



AXIOMA L ø100 cm
Box in chromed brass /
Caja en latón cromado

Hands in black, white or red lacquered walnut wood /
Agujas en madera de lacada negra, blanca o roja



AXIOMA MINI L ø37 cm
Box in chromed brass /
Caja en latón cromado

Hands in black, white or red lacquered walnut wood /
Agujas en madera de lacada negra, blanca o roja



AXIOMA G ø74 cm / 100cm
Box in polished brass /
Caja en latón pulido

Hands in walnut or wenge wood /
Agujas en madera de nogal o wengué



AXIOMA MINI G ø37 cm
Box in polished brass /
Caja en latón pulido

Hands in walnut or wenge wood /
Agujas en madera de nogal o wengué



AXIOMA T ø74 cm / 100cm
Box in graphite finished brass /
Caja en latón acabado grafito

Hands in walnut or wenge wood /
Agujas en madera de nogal o wengué



AXIOMA MINI T ø37 cm
Box in graphite finished brass /
Caja en latón acabado grafito

Hands in walnut or wenge wood /
Agujas en madera de nogal o wengué

Custom Made TECHNICAL INFORMATION

1

NUMBERS IN POLISHED STEEL

Height: 5 - 7 cm / Altura: 5 - 7 cm
Thickness: 0,3cm / Espesor: 5 - 7cm



6

NUMBERS IN WALNUT OR WENGE WOOD

Height: 5 - 7 cm / Altura: 5 - 7 cm
Thickness: 0,3 cm / Espesor: 5 - 7 cm



4

NUMBERS IN METHACRYLATE

Height: 5 - 7 cm / Altura: 5 - 7 cm
Thickness: 0,3 cm / Espesor: 5 - 7 cm



SMALL CLOCKS UP TO Ø55 CM



OJ Mini
Ø50 cm
P.198-199



Pico
Ø40 cm
P.202-207



Axioma Mini
Ø37 cm
P.220-221



Bari
Ø24 cm / Ø32cm
P.186-189



Sunset
Ø50 cm
P.136-137



Dos Puntos
Ø43 cm
P.92-95



Dos Puntos Premium
Ø43 cm
P.28-29



Micro Barcelona
Ø42 cm · H54 cm
P.58-59



Micro Anda
Ø40 cm
P.82-83



Rodón mini L
Ø50 cm
P.134



Ciclo
Ø55 cm
P.36-39



Puntos Suspensivos
Ø50 cm
P.135



Brisa
Ø52 cm
P.40-43



Micro Eslabón
Ø10 cm · H26cm
P.124-125



Micro Daro
Ø40 cm
P.90-91



Nano
Ø28 cm
P.212-213

MEDIUM CLOCKS



OJ
Ø80 cm
P.198-199



Axioma N, G, T
Ø74 cm / Ø100 cm
P.120-121



Axioma i
Ø74 cm / Ø100 cm
P.120-121



Mini Merlín
Ø70 cm
P.146-147



Mini Barcelona
Ø66 cm · H76 cm
P.56-57



Mini Barcelona Premium
Ø66 cm · H76cm
P.24-27



Mini Bilbao
Ø77 cm · H92cm
P.64-67



Doble O
Ø70 cm
P.96-99



Doble O Premium
Ø70 cm
P.30-31



Rodón
Ø70 cm
P.132-133



Tacón i
Ø74 cm
P.138-141



Cris
Ø80 cm
P.100-103



Mini Look
104 x 33cm
P.70-71



Brisa XL
Ø75cm
P.44-45

LARGE CLOCKS



Axioma L
Ø100 cm
P.218-219



New anda
Ø100 cm
P.78-81



Delmori
Ø130 cm · H140cm
P.72-77



Barcelona
Ø90 cm · H100 cm
P.50-55



Barcelona Premium
Ø90 cm · H100 cm
P.18-23



Bilbao
Ø105 cm · H110cm
P.60-63



Look
140 x 49 cm
P.68-69



Merlín
Ø110 cm / Ø125 cm / Ø155 cm
P.142-145



Mixto
Ø110 cm / Ø125 cm / Ø155 cm
P.148-149



Daro
Ø70 cm · H108cm
P.84-89



Tacón L,G,T
Ø74 cm / Ø100 cm
P.138-141

TABLE & FLOOR CLOCKS



Atomo
Ø10 cm · H10,5 cm
P.170-175



Mini Puntero
Ø10 cm · H26 cm
P.176-179



Nene & Nena
Ø10 cm · H22 cm
P.180-181



Aire
Ø50 cm · L55cm
P.156-157



Mini Aire
Ø26 cm · H30 cm
P.158-159



Omega
Ø43 cm · L40 cm
P.160-161



Pisa
Ø74 cm · H150 cm
P.164-165



Puntero
Ø74 cm · H94 cm
P.162-163

PENDULUM CLOCKS



Punta
Ø28 cm · H63 cm
P.208-211



Punto y Coma
Ø37 cm · L113 cm
P.110-113



Péndulo
Ø60 cm · L (max 4m)
P.114-117

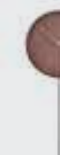

Swing
Ø34 cm · L80 cm
P.118-119



Colgante
Ø30 cm · H79 cm (L max 4m)
P.126-127



Eslabón
68 x 30cm
P.120-123

Tiempo de entrega DELIVERY TIME

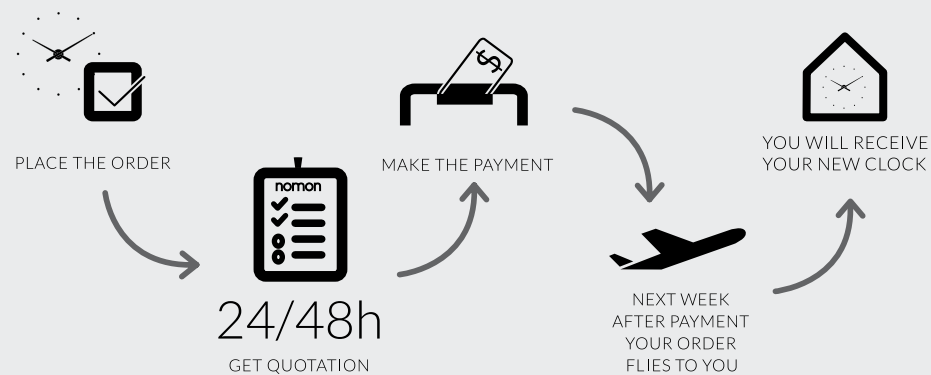

ADMINISTRATION

T. (+34) 933 86 585 - ext 2
info@nomones

EXPORT

T. (+34) 933 86 585 - ext 3
export@nomones

TECHNICAL SERVICE

T. (+34) 933 86 585 - ext 1
produccion@nomones

SOCIAL MEDIA

Instagram · nomonclocks_home
Facebook & Pinterest · Nomon Clocks Home
communication@nomones



INSTAGRAM

ACCOUNT



HEADQUARTERS

OFICINAS CENTRALES

Carrer Tucumán, 6 - 2nd floor
08030 BARCELONA

T. (+34) 933 86 585

F. (+34) 933 86 201

NOMON SHOWROOM

Passatge Maïol, 4

08013 BARCELONA

T. (+34) 936 638 497

HEADQUARTERS OPENING HOURS

HORARIO OFICINA

Lunes a Jueves / Monday to Thursday

09:00-14:00 / 15:00-18:00

Viernes / Fridays

08:00-16:00

SHOWROOM OPENING HOURS

HORARIO SHOWROOM

Martes a Viernes / Tuesday to Friday

09:00-14:00 / 15:00-19:00

Sábado / Saturday

10:00-15:00

Lunes cerrado / Monday closed

CREDITS

Art Direction:
Antoni Pallejà Office

Photography:
Marcel Juan
Paco Deogracias
Cualiti Studio

Printing:
9-disseny

Copyright © 2022 Nomon
All rights reserved
Todos los derechos reservados

WWW.NOMON.ES

